

INSTALLATION AND USER MANUAL



DC INVERTER AIR TO WATER HEAT PUMP

POWER

9 kW
15 kW
22 kW

SUPPLIER

MODEL

ECOHEAT-MHP9
ECOHEAT-MHP15
ECOHEAT-MHP22



**FOR OUTDOOR
INSTALLATION ONLY**

BOILER UPGRADE SCHEME (ENGLAND AND WALES)

The Boiler Upgrade Scheme is open to people in England and Wales and can provide a grant to cover part of the cost of replacing a fossil fuel heating system with a heat pump, when installed by an MCS certified installer.

You're eligible for a grant if all the following are true:

- Own the property you're applying for (including if it's a business, a second home, or a property you rent out to tenants)
- The Property has a valid Energy Performance Certificate (EPC) with no outstanding recommendations for loft or cavity wall insulation.
- Have installed (or plan to install) your new heating system on or after 1 April 2022
- Be replacing fossil fuel heating systems (such as oil, gas or electric)

You're still eligible if you've already had funding to make your property more energy efficient, for example by insulating it.

You cannot get a grant for:

- Most new build properties.
- Social housing.
- A property that's already been given government funding or support for a heat pump or biomass boiler.

How to apply:

- Contact suitable MCS certified installers to get quotes for the work.
- Confirm you're eligible (your installer can help advise).
- Agree a quote with your chosen installer.

Details correct at the time of writing (November 2023). We advise you check <https://www.gov.uk/apply-boiler-upgrade-scheme/check-if-youre-eligible> to check for any published changes to the scheme.

FINDING AN MCS CERTIFIED INSTALLER

MCS manages a register of certified contractors for a range of technologies. You can find a local certified engineer using their search tool found at:

<https://mcs-certified.com/find-an-installer/>

CONTENTS

SAFETY INSTRUCTIONS	3
HOW TO CHOOSE A SUITABLE HEAT PUMP	6
KEY FEATURES	7
PRODUCT OVERVIEW	7
PRODUCT DIMENSIONS	8
PARTS SUPPLIED	9
PLANNING YOUR INSTALLATION	10
SYSTEM DIAGRAMS	11
INSTALLATION GUIDE	13
POSITIONING THE HEAT PUMP	14
SECURING THE HEAT PUMP	15
CONNECTING THE WATER LOOP	15
ELECTRICAL CONNECTION	16
BEFORE FIRST OPERATION	17
INSPECTION	17
TRIAL RUN	17
OPERATION	18
HOME SCREEN	18
TURNING THE UNIT ON AND OFF	19
LOCKING THE CONTROLLER	19
SELECTING THE MODE	20
SETTING THE TARGET TEMPERATURE	21
WITH ZONE CONTROL DISABLED	21
HEATING MODE MULTI-ZONE CONTROL	22
COOLING MULTI-ZONE CONTROL	26
STATUS INTERFACE DISPLAY	26
OPTION MENU	27
1. TIME MENU	28
1.1 SYSTEM TIME SETTING	28
1.2 POWER TIMER MENU	29
1.3 WARM WATER CIRCULATION CONTROL	30
1.4 MUTE TIMER	31
2. PARAMETER MENU	32
3. CURVE MENU	32
4. SMART GRID MENU	33
4.1 SG READY	33
4.2 MODE & TEMP POWER TIMER	36
5. SCREEN BRIGHTNESS	37
6. FAULT RECORD	38
7. ELECTRIC HEATING	38
GETTING TO KNOW THE SMART APP	39
COMMUNICATION MODULE	39
ADDING THE DEVICE	41
USING THE APP	42
CLEANING AND MAINTENANCE	45
FAULT CODES	47
FREQUENCY CONVERSION BOARD FAULT TABLE	49
WIRED CONTROLLER INTERFACE DIAGRAM	51
CIRCUIT DIAGRAMS	52
MAIN BOARD CONNECTORS	55
WATER QUALITY REQUIREMENTS	56
TECHNICAL DATA	57
SUPPORT	58

SAFETY INSTRUCTIONS

Thank you for purchasing this heat pump which is produced following strict design and manufacturing standards to provide a high quality, reliable and versatile product. This manual includes all the necessary information about installation, debugging, discharging and maintenance. Please read this manual carefully before installation or use.

The manufacture of this product will not be held responsible for injury or damage resulting from improper installation, debugging, or maintenance which is not in line with this manual. The unit must be installed by qualified personnel.

It is vital that the instructions are adhered to at all times. The unit can only be opened or repaired by a qualified installer or an authorised dealer. Maintenance must be carried out according to the recommended time and frequency, as stated in this manual. Failure to comply with these recommendations will invalidate the warranty.

IMPORTANT!

- To prevent the unit from causing harm or damage, please read this manual carefully and understand the following information correctly.
- Rating: This unit must be only connected to a 220-240 V / 50 Hz earthed supply.
- The circuit the appliance is connected to must be protected by a suitably rated RCD.
- The heat pump must be installed by qualified personnel, to avoid improper installation which can lead to water leakage, electrical shock or fire.
- Installation must be in accordance with regulations of the country where the unit is used.
- If you are in any doubt about the suitability of your electrical supply have it checked and, if necessary, modified by a qualified electrician.
- This heat pump has been tested and is safe to use. However, as with any electrical appliance - use it with care.
- Disconnect the power from the appliance before dismantling, assembling or cleaning.
- If the appliance malfunctions, or if there is a strange smell, the unit

should be turned off, and the power disconnected. Continued use may cause electrical short or fire.

- Avoid touching any moving parts within the appliance.
- Never insert fingers, pencils or any other objects through the guard.
- This appliance is not intended for use by persons (including children) with reduced physical, sensory or mental capabilities. It is also not intended for use by those with a lack of experience and knowledge, unless they have been given supervision or instruction concerning the use of the appliance by a person responsible for their safety.
- Do not leave children unsupervised with this appliance.
- Do not clean the unit by spraying it or immersing it in water.
- Maintenance must be carried out according to the recommended frequency given within this manual.
- Only genuine spare parts can be used. The use of parts or accessories not approved by the manufacturer will invalidate the warranty.
- This appliance is designed to be hardwired, and must be connected to a suitable all pole outdoor isolator switch, which must be installed in an accessible place close to the heat pump.
- Ensure the appliance is suitably secured in its final position to prevent the risk of tipping.
- The unit should be inspected monthly to ensure the mounting is secure.
- Never operate this appliance if the power cord is damaged. Ensure the power cord is not stretched or exposed to sharp objects/edges.
- A damaged supply cord should be replaced by the manufacturer or a qualified electrician in order to avoid a hazard.
- Any service other than regular cleaning should be performed by a qualified engineer. Failure to comply could result in a voided warranty.
- Do not use the appliance for any purpose other than its intended use.
- The heat pump unit must always be stored and transported upright, otherwise irreparable damage may be caused to the compressor; if in doubt we suggest waiting at least 24 hours before starting the unit.

- Avoid restarting the heat pump unless 3 minutes have passed since being turned off. This prevents damage to the compressor.
- Install the unit on a dry and stable surface.
- Do not use the product and contact the retailer for advice, if damage has occurred to the unit which may have compromised the refrigerant system.
- The refrigerant system should not be perforated or punctured.
- Do not use means to accelerate the defrosting process or to clean, other than those recommended by the manufacturer.
- The appliance shall be stored in a room without continuously operating ignition sources (For example: Open flames, an operating gas appliance or electric heater.)
- Be aware that refrigerants may be odourless.
- Before gaining access to the terminals, all supply circuits must be disconnected.
- Any procedures which may affect the safety of the product must be conducted by a competent person after reading the service manual available from the manufacturer.
- Children should be supervised to ensure that they do not play with the appliance.
- The unit CANNOT be installed near flammable gas. Once there is any leakage of the gas fire can occur.
- The heat pump located inside the unit is equipped with an over-load protection system. It does not allow for the unit to start for at least 3 minutes from a previous power cut.
- DO NOT touch the heat exchanger of the heat pump with fingers or other objects.
- Decommissioning and/or moving the appliance must be conducted by a suitably qualified person. Failure to adhere to this could lead to water leakage, electrical shock, injury or fire.
- This appliance is designed for outdoor installation only. It should not be stored in a room with potential ignition sources (e.g. open flames, operating gas appliance or electric heater)

HOW TO CHOOSE A SUITABLE HEAT PUMP

HEATING REQUIREMENTS

The heating requirements for your home should be calculated, both in terms of room heating/cooling and the demand for hot water. When calculating this, there are many factors to consider including:

- Local climate conditions.
- Energy performance of the property.
- Construction features such as number of windows.

From the above, a professional will be able to calculate the heating capacity required per square meter, and in turn the total heating capacity required from the heat pump.

Once it is understood what capacity is required, the features of individual models should be compared to choose the one which best meets the requirements. This heat pump is suitable for operating at ambient temperatures between -25°C and 43°C , although performance will be affected depending on the ambient temperature.

This heat pump also utilises inverter technology, allowing the heat output to be adjusted dependant on demand, to help ensure that the correct balance of performance and efficiency is achieved.

For larger properties such as offices, hotels and commercial spaces, it may be beneficial to zone the areas, with a separate heat pump covering different areas of the property.

KEY FEATURES

- **Advanced Controller** - Includes an intelligent controller allowing adjustment of the running parameters.
- **Built-in Water Pump** - The Monoblock has the water pump included for ease of installation.
- **Flexible installation** - The unit has smart structure with a compact body, just simple outdoor installation is needed.
- **Quiet Running** - High quality and efficient compressor, fan and water pump are used in conjunction with insulation to ensure quiet operation.
- **Highly Efficient** - The heat pump unit uses a specially designed heat exchanger to enhance the efficiency.
- **Low Temperature Operation** - This heat pump is designed to function in working conditions down to -25°C for heating.

PRODUCT OVERVIEW

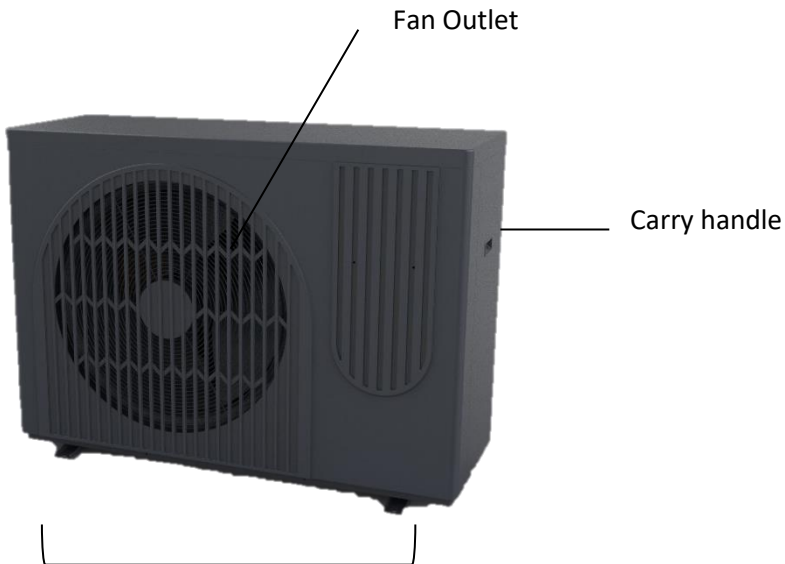

PRODUCT DIMENSIONS

ECOHEAT-MHP9

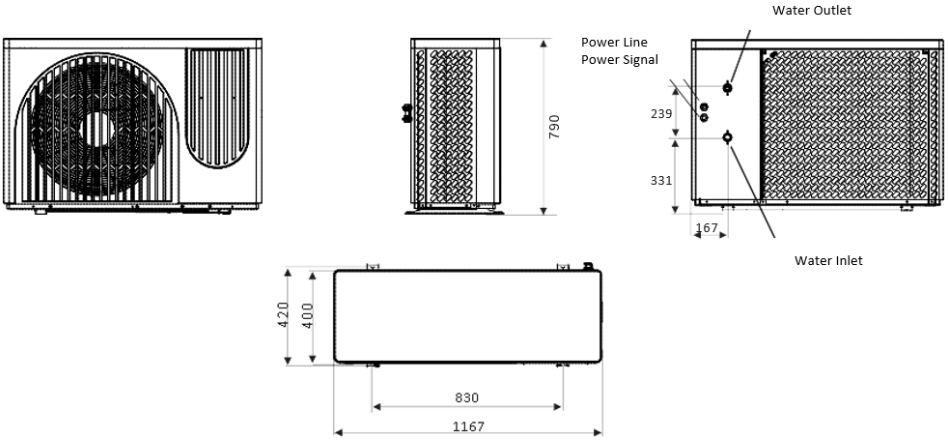

ECOHEAT-MHP15

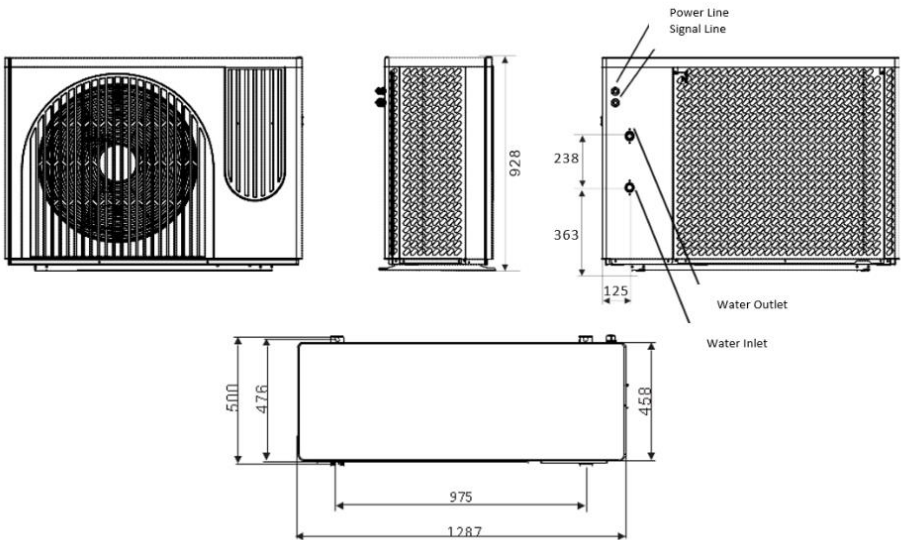

ECOHEAT-MHP22

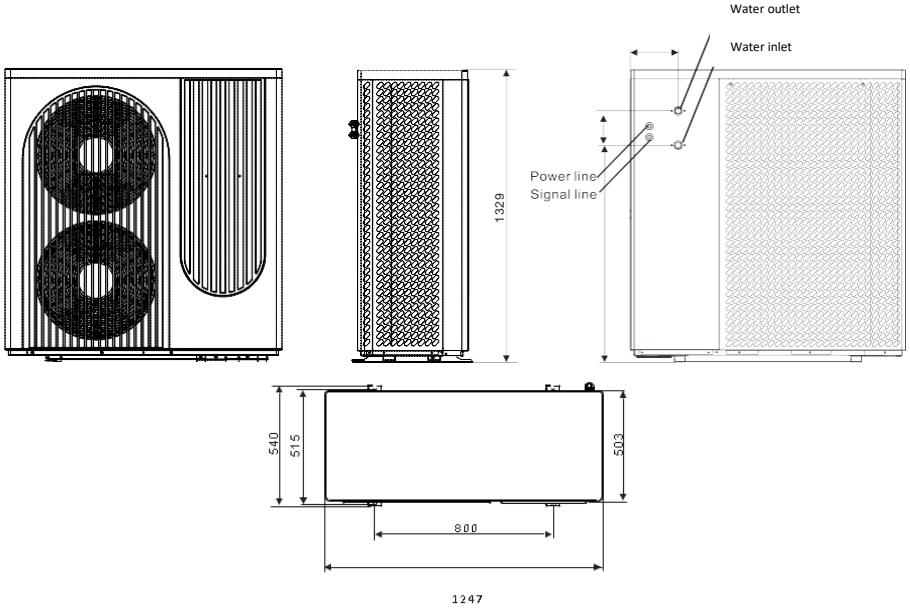

PARTS SUPPLIED



Heat pump Unit



Wired Controller



Rubber Feet (x4)



Drain Adaptor (x2)



10m Controller Cable



Tank Temperature Sensor

PLANNING YOUR INSTALLATION

This Monoblock heat pump can be set up to provide heating, cooling and domestic hot water. Floor heating loops and radiators can be used for heating, and fan coil units can be connected to provide both cooling and heating. Domestic hot water is provided from a separate domestic hot water tank (DHW tank) connected to the heat pump.

It is important that the system is fully planned before installation, and that you are sure you have all the required parts to complete the system.

The system comprises of a DHW tank providing hot water to the premises and a separate Buffer tank providing heat to radiators, fan coils and underfloor heating. The engineer installing the unit would need to connect the heat pump to the system, which in addition to the tanks would usually require 2 water pumps (for water circulation in the heating/cooling system, and hot water), safety valve, water charge valve and a hot water valve, as well as other associated equipment. You would also need to consider if further temperature sensors are required, depending on the requirements and design of the system. See the system diagrams for further information.

The temperature sensor should be added to the DHW tank. Additional electric heaters and sensors can be installed in either tank, and its control signal can be provided by the heat pump.

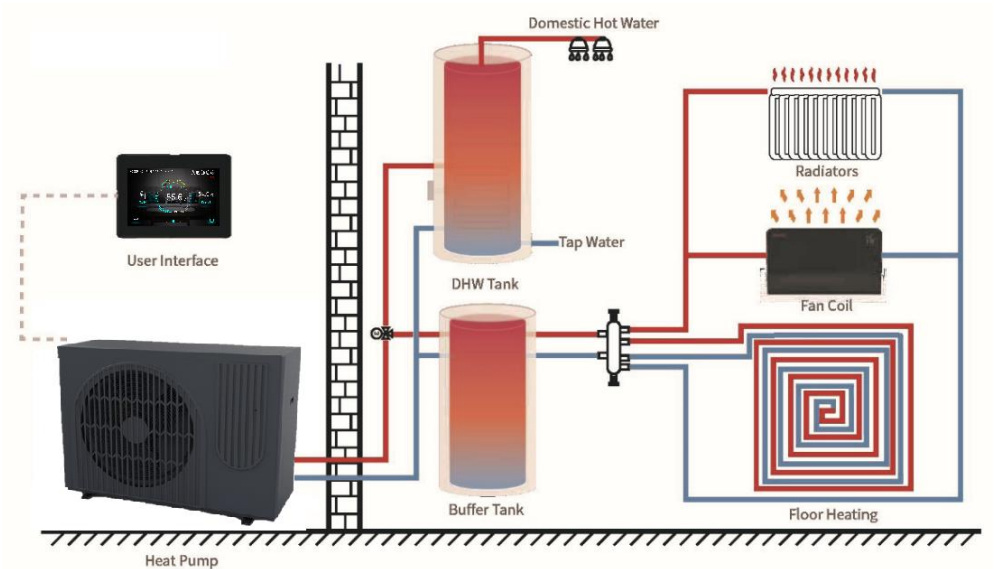

SYSTEM DIAGRAMS

Each installation is different. It is important that the system is designed considering the needs of the user and premises where the appliance is installed. The following two are examples of best practice based on the most common application.

HOUSE HEATING/COOLING + DOMESTIC WATER

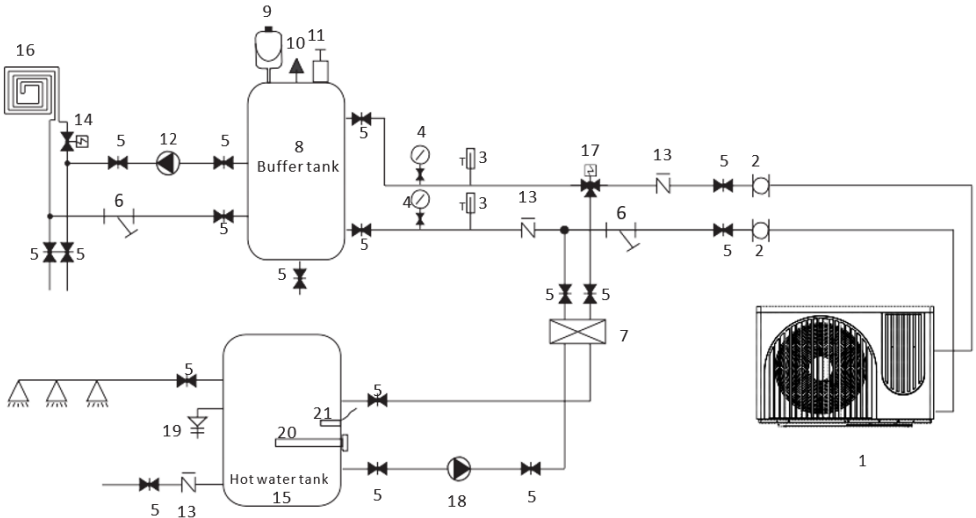

1	Heat pump	12	Water pump for floor
2	Flexible hose	13	Check valve
3	Thermometer	14	Floor heating valve
4	Manometer	15	Hot water tank
5	Shut off valve	16	Floor heating pipe/fan
6	Y type water	17	Hot water valve
7	Plate heat	18	Hot water pump
8	Buffer tank	19	PT valve
9	Expansion tank	20	Electrical heater
10	Relief valve	21	Hot water sensor
11	Air vent valve		

NOTE: 17, 18, 20, 21 can be connected with heat pump.

HOUSE HEATING/COOLING ONLY (NO HOT WATER)

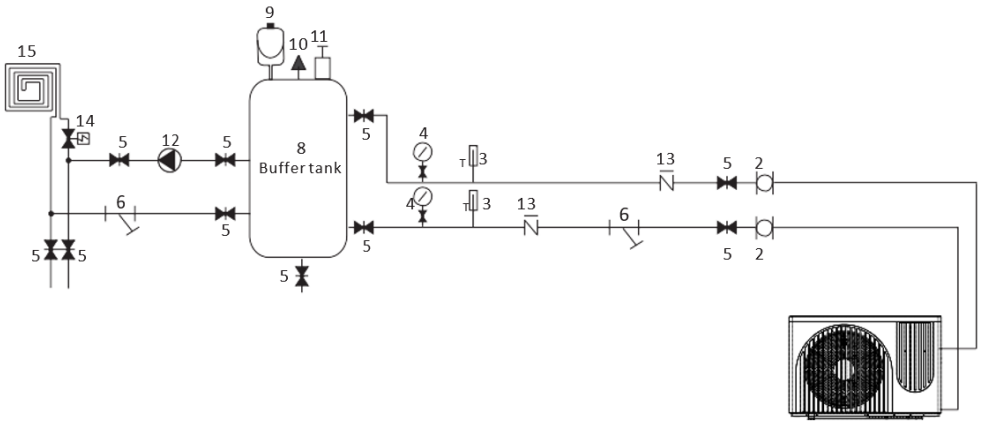

1

1	Heat pump	9	Expansion tank
2	Flexible pipe	10	Relief valve
3	Thermometer	11	Air vent valve
4	Manometer	12	Water pump for floor heating
5	Shut-off valve	13	Check valve
6	Y type water filter	14	Floor heating valve
7	Plate heat exchanger	15	Floor heating pipe/fan coil unit
8	Buffer tank		

INSTALLATION GUIDE

SAFETY WARNINGS

- This installation manual is intended for use by individuals possessing adequate backgrounds and qualifications.
- This appliance is designed for installation by an MCS certified engineer.
- Any attempt to install or repair the appliance may result in personal injury and/or property damage.
- The manufacturer, importer and retailer cannot be held responsible for the interpretation of this information, nor can it assume any liability in connection with its use.
- The units are designed for permanent installation.
- The equipment is designed for domestic or office use and we are not making any endorsements for its use in industrial or maritime environments.
- Do not place near sources of heat, vapours, industrial machine oil or other flammable gases.
- High frequency waves generated by radio equipment, welders and medical equipment will interfere with the normal operation of the unit.
- Install this device only when it complies with local/national legislation, ordinances and standards.
- Check the mains voltage and frequency. This unit is only suitable for an earthed electrical supply, connection voltage 220-240 V / 50 Hz.
- The information, specifications and parameter are subject to change due to technical modifications or improvement without any prior notice. The accurate specifications are presented on the rating label found on the appliance.
- Please read this installation manual completely before installing the product.
- When the power cord is damaged, replacement work shall be performed by authorised personnel only.
- Installation work must be performed in accordance with all European, national and / or local directives and standards and must be conducted by authorised personnel only.
- Always make sure to wear the correct personal safety protections such as protective eyewear, gloves, ear protection etc.

POSITIONING THE HEAT PUMP

- A convenient position, dry and well ventilated, outside of direct sunlight or strong winds, which is not on flood line and where noise and airflow does not cause interference or inconvenience.
- Select a location where there are no obstructions to the inlet and outlet vents.
- The location should be able to withstand the full weight and vibration of the outdoor unit and permit safe installation.
- Make sure that there is easy access for maintenance.
- Select a place where it is out of reach of children.
- Do not block utilities access or fire escapes.
- The external unit must be lifted and put in place by two people or by specialised equipment.
- There must be water channel around the heat pump to drain the condensing water.

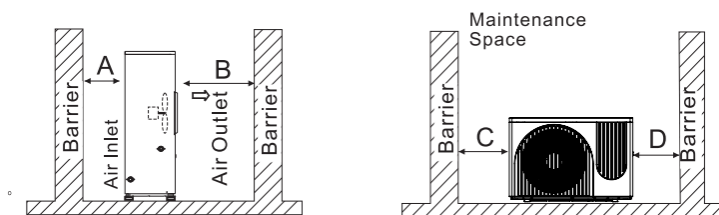

The picture shows the location of horizontal air outlet unit.

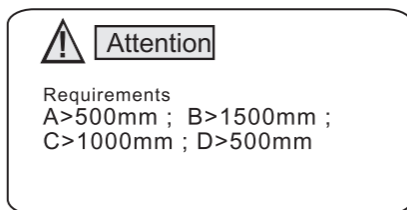

The minimum ventilation distance in diagram 1.

NOTES:

- Only use the correct power supply voltage making sure the correct sized power cables are used
- The appliance shall be installed in accordance with standard wiring regulations by qualified personnel.
- Only replace fuses according to their printed rating or corresponding pcb boards.

SECURING THE HEAT PUMP IN POSITION

The heat pump should be secured using expansion bolts (not included), onto a concrete base or a suitable steel wall mount. When installing the rubber feet must be attached to help prevent vibrations. Care should be taken to ensure that the product is horizontal to prevent issues with water drainage.

If the unit needs to be raised to a height during installation, it should be secured using an 8-meter cable. There must be soft material like padding between the cable and the unit to prevent damage to the heat pump cabinet during the lift

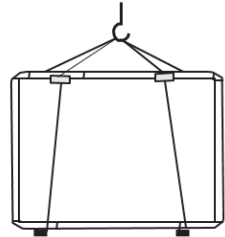

CONNECTING THE WATER LOOP

The heat pump includes 1-inch (external diameter) inlet and outlet connections for attaching to the water loop, this can be connected to either metal or plastic pipe.

- Try to reduce the resistance to waterflow within the pipework, by limiting lengths and bends as far as practical, as this may affect performance.
- As part of the system design, the pipe diameter should be considered, as using 1.25" diameter pipework for the loop, may increase performance.
- Given the variety of pipework which may be used for the installation, it is not possible for pipe connectors / adaptors to be provided for attaching the water loop, and so it is the installers responsibility to ensure that a suitable watertight connection is made to the appliance.
- The pipework must be free from blockages, restrictions and dirt.
- A water leakage test must be conducted to ensure the system is watertight prior to installing the insulation on the pipework. This test should be conducted before the pipework is connected to the heat pump.
- An expansion tank must be installed at the top point of the water loop.
- The water level in the tank must be at least 0.5 meter higher than the top point of the water loop.
- The flow switch is integrated within the heat pump, the operation of this should be tested before use.
- Care should be taken to prevent air locks within the water pipe. An air vent should be installed at the top point of the water loop to allow removal of any air within the system.
- There must be thermometer and pressure meter at the water inlet and outlet for easy inspection during operation.
- As the water loop will be exposed to sub zero temperatures, Ethelene glycol should be used to lower the freezing point. We would suggest a solution of around 30-40% Ethelene glycol as suitable for the UK climate.
- As the water temperature can reach 75°C, when selecting suitable pipework, the installer must ensure it is suitable to withstand the temperatures it may be exposed to.

ELECTRICAL CONNECTION

- Remove the lid from the heat pump before removing the end panel to access the electrical connections.
- The power cable should be routed through the IP rated cable grip on the side of the unit and connect to the supply terminals in the control box.

Preconnected to unit

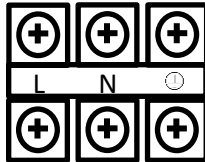

Wire to a suitable 230V Supply

The circuit must be RCD protected, and an all pole disconnection device must be installed in an accessible place close to the heat pump.

- Care should be taken when routing any cables, and high current cables such as the power cable should be routed through the top cable grip, and lower current cables through the lower cable grip. This will help to prevent interference and faults.
- The wired controller should then be wired into the black connector, which is pre-fitted to the unit, using the extension cable. If the supplied 10m extension cable is not long enough, this can be extended by splicing in a length of 5 core 0.5mm² cable, or a longer extension cable is available from the manufacturer.
- The Thermometer should also be routed in the same way from the relevant connections on the side of the unit to the water tank. The connection point is labelled, and is also shown on the circuit diagram within this manual.
- Any other auxiliary parts and sensors which require communication with the heat pump should also be connected at this point, following the circuit diagram within this manual.
- Once all the connections have been made, the side panel and top cover should be replaced on the unit and secured.

BEFORE FIRST OPERATION

INSPECTION

Check the indoor system ensuring that all pipe connections are correct and that the relevant valves are open.

1. Check the water loop, to ensure that the water/glycol mixture inside of the expansion tank is adequate, the water supply is good, the water loop is full of water and that there is no air in the pipework.
2. Ensure that all pipework is adequately insulated.
3. Check the electrical wiring, to ensure that the voltage is correct, the screws are fastened and the wiring is made in line with the supplied diagrams.
4. Check the heat pump unit including all of the screws and parts of the heat pump to check that it is correctly reassembled and secure.
5. When powered on, review the indicator on the controller to see if there is any failure indication. Fault codes are provided later in this manual.
6. A pressure gauge can be connected to the check the valve to see the high pressure (or low pressure) of the system during trial running.

TRIAL RUN

- Start the heat pump by pressing the  button on the controller. Check whether the water pump is running, if it runs normally there will be 0.2 MPa on the water pressure meter.
- When the water pump has been running for 1 minute, the compressor will start. Listen for whether there is a strange sound from the compressor. If an abnormal sound occurs, please stop the unit and check the compressor. If the compressor runs well check the pressure of the refrigerant, or contact the supplier.
- Adjust the valves on the water loop to make sure that the water supply to the inlet and outlet is sufficient and meets the requirements for heating (or cooling).
- Review whether the outlet water temperature is stable.

OPERATION

HOME SCREEN OVERVIEW



No.	Function	Description
1	Screen Lock	Press to lock and unlock the control panel
2	Main interface	Indicated that the current page is in the Home Screen
3	DHW Temperature	When in DHW (Domestic Hot Water) mode, this icon is displayed, and shows the temperature of the water tank.
4	ON/OFF	Press to turn the unit on and off. When the button is blue, it means that the unit is on, when the button is white, it means that the unit is in standby mode.
5	Target Menu	When pressed, the unit will enter the target water temperature menu.
6	Inlet Temperature	Displays the temperature of the water returning to the unit.
7	Target Temperature	Displays the temperature the heat pump is aiming for.
8	Fault	If there is a fault detected within the unit, this icon will be displayed.
9	Defrost	During automatic defrost mode, this icon will be displayed.
10	Mute	When the timer is muted (temporarily turned off), this icon will be displayed.
11	Timer	When the timer is enabled, this icon will be displayed.
12	Mode/Temp	Displays when the unit is operating under the timer.
13	Smart Grid	This icon will be displayed when enters SG Ready, SG Ready includes five modes: Solar Sleep Mode, Solar Low Mode, Solar Medium Mode, Solar High Mode, Normal Mode
14	Ambient Temp	Displays the current ambient temperature.
15	Time/Date	Displays the time and date.
16	Running mode	Shows the current running function.
17	Mode Selection	Press to enter the mode selection interface. There are five modes: Heating, Cooling, Hot Water + Cooling, Hot Water + Heating.



TURNING THE UNIT ON AND OFF

Press the Power button to turn the heat pump on and off.



Power icon blue	Heat pump is on
Power icon white	Heat pump is in standby

LOCKING THE CONTROLLER

Press the  symbol to lock the controller. Press the  symbol again to unlock the controller. When unlocking you will be required to enter the password (Default password: 22) to unlock as shown below.

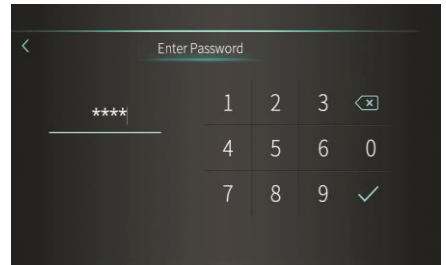

SELECTING THE OPERATING MODE

There are five modes that can be selected after pressing the mode button on the home screen:

1. **DHW** (DOMESTIC HOT WATER ONLY)
2. **HEATING MODE** (HEATING ONLY)
3. **COOLING MODE** (COOLING ONLY)
4. **DHW + HEATING** (DOMESTIC HOT WATER AND HEATING)
5. **DHW + COOLING** (DOMESTIC HOT WATER AND HEATING)

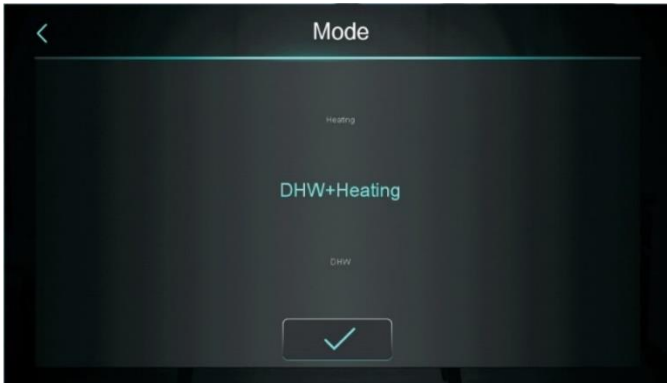

Select the mode you require the unit to operate in, and press the tick to confirm and return to the home screen.

SETTING THE TARGET TEMPERATURE

The options available in the Target temperature menu will vary depending on the mode which the unit is operating, and whether Zone control is activated. This can be activated within the Parameter Menu.

ZONE CONTROL DISABLED

- Press (1) to go return to Home and discard unsaved changes.
- Use the dials (2) to increase or decrease the water temperature. Note: The temperatures for Heating and DHW tanks are set separately.
- Press (3) to save the updated temperatures.



When room temperature control is activated, press the room temperature display in the main interface to enter the target room temperature page, and slide the adjustment to set the target temperature of the room.

See the ZONE CONTROL FUNCTION PARAMETERS for details about activating and disabling Zone Control.

HEATING MODE MULTI-ZONE CONTROL SCREEN

When using a heating mode, press “Heating Multi-Zone control” on the Target temperature page to enter the multi-zone control centre:

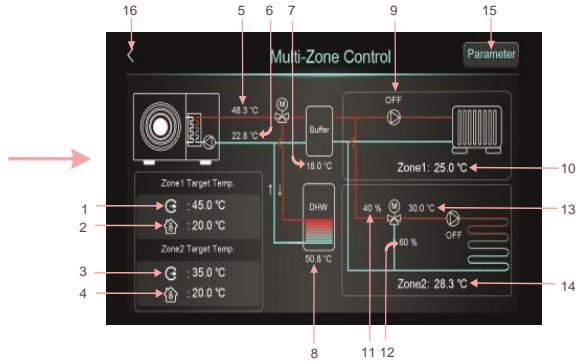

1	Display target outlet temperature in zone 1/target outlet water temperature after compensation
2	Display room target temperature in zone 1, when Z01=4/5/6/7/8/9, it displays “/”
3	Display target outlet temperature in zone 1/target outlet water temperature after compensation
4	Display room target temperature in zone 2, when Z01=4/5/6/7/8/9, it displays “/”
5	Display outlet water temperature
6	Display inlet water temperature
7	When H25=buffer tank control, display buffer tank temperature When H25≠buffer tank control, display ---, and Buffer will become “Not used”
8	Display Tank temperature
9	When zone 1 pump turns on, display “ON”, otherwise display “OFF”
10	Display zone 1 room temperature. When Z01=4/5/6/7/8/9, it means the unit is connected to the passive switch thermostat or room thermostat, and the unit will just receive the signal, when the thermostat asks the unit to turn on, then here will show Zone1: Start, otherwise, it will show Zone1: Stop.
11	Display the percentage of zone 2 mixing valve steps.
12	Display 100 - the percentage of zone 2 mixing valve steps
13	Display zone 2 mixing water temperature
14	Display zone 2 room temperature. When Z01=4/5/6/7/8/9, it means the unit is connected to the passive switch thermostat or room thermostat, and the unit will just receive the signal, when the thermostat asks the unit to turn on, then here will show Zone2: Start, otherwise, it will show Zone2: Stop.
15	After pressing, enter password , will enter the multi-zone function parameter list.
16	Press to return the main screen.

ZONE CONTROL MENU

Press **Parameter** on the Multi-Zone Control screen and enter the password (Default Password: 22) to enter the zone control menu.

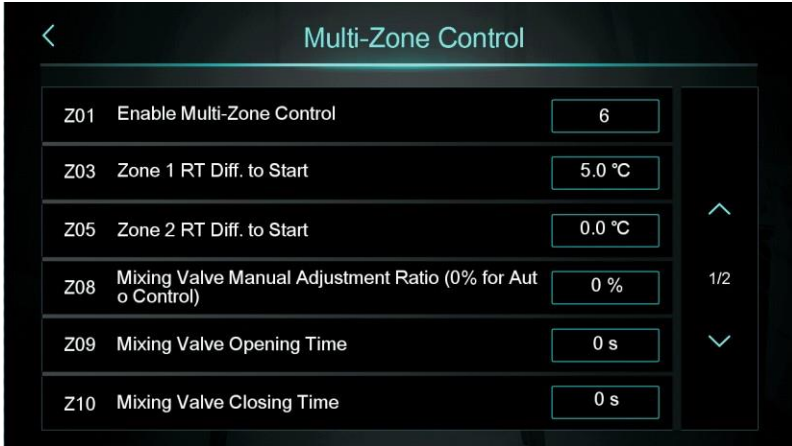

In addition to being able to use the options to make amendments to the operation such as the level of temperature drop before heating restarts, it also provides the option to activate and deactivate the Multi-Zone Control for each zone.

When Z01=0, disable zone 1 and zone 2, display Not Used;



When Z01=2/5/8, disable Zone 1.

When Z01=1/4/7, disable Zone 2.

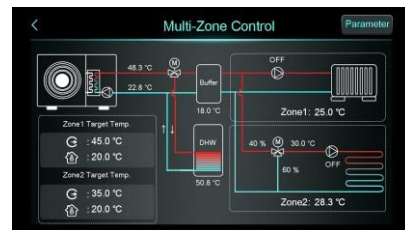
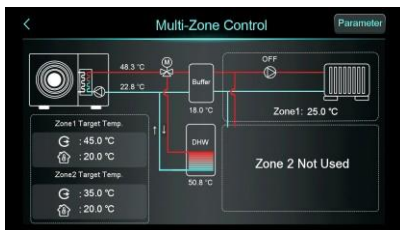
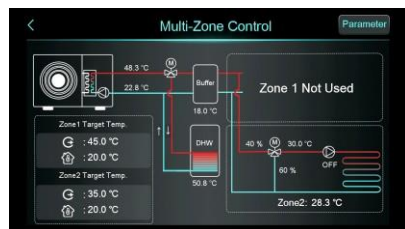
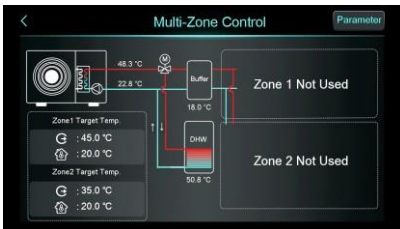
When Z01=3/6/9, enable Zone 1 and Zone 2.



ZONE 1 TARGET TEMPERATURE MENU

Press  : 45.0 °C
 : 20.0 °C to adjust the target temperatures for zone 1:



1	Zone 1 Set Target WT	Press to set the target outlet water temperature for Zone 1.
2	Zone 1 Target RT	Press to set target temperature of the room for Zone 1, when zone 1 is disabled it will display “/”
3	Zone 1 AT-WT Compensation	Press to enter the zone 1 weather compensation curve, When the zone 1 weather compensation is disabled, it will display NOT USED. Enable to display the compensated temperature. It can only be activated when Zone 1 is active and Z16 on the zone control menu =1

ZONE 1 WEATHER COMPENSATION CURVE

Used to adjust performance based on the external temperature.

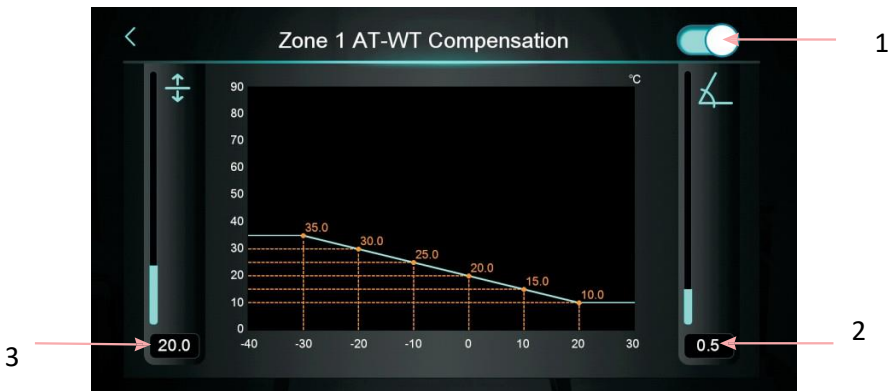



1	Enable	Enable weather compensation.
2	Slope	Set the slope by sliding up and down or pressing on the value
3	Offset	Set the offset by sliding up and down or pressing on the value

Celsius calculation formula:

Compensated temp. = -Slope*Current AT + Offset
 Fahrenheit calculation formula: Compensated Target = -Slope*(Current AT-32)+ Offset

ZONE 2 TARGET TEMPERATURE MENU

Press  : 35.0 °C
 : 20.0 °C to enter the target temperature for zone 2:



1	Zone 2 Set Target WT	Press to set zone 1 target outlet water temperature
2	Zone 2 Target RT	Press to set zone 2 room target temperature, when zone 2 is disabled, it will show “/”
3	Zone 2 AT-WT Compensation	Press to enter the zone 2 weather compensation curve, When the zone 2 weather compensation is disabled, it will display NOT USED. Enable to display the compensated temperature. It can only be activated when Zone 1 is active and Z16 on the zone control menu =1

ZONE 2 WEATHER COMPENSATION CURVE

Used to adjust performance based on the external temperature.

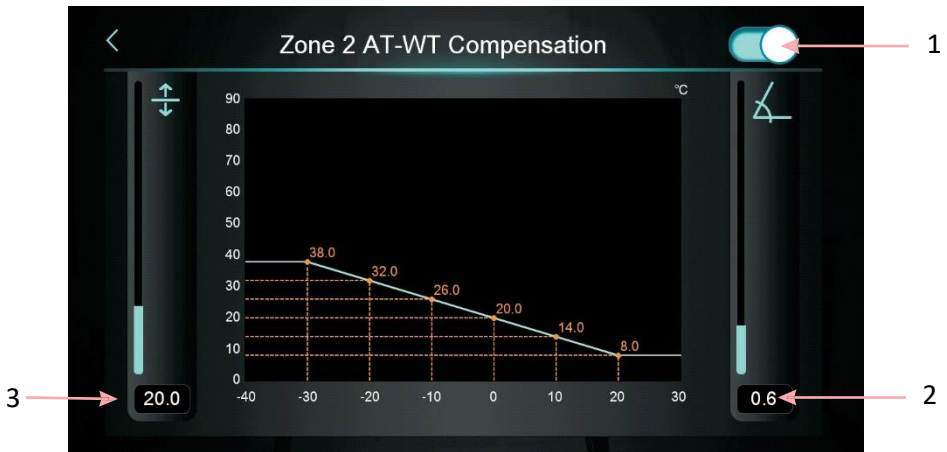

1	Enable	Enable weather compensation
2	Curve	Set the curve by sliding up and down or pressing on the value
3	Offset	Set the offset by sliding up and down or pressing on the value

COOLING MULTI-ZONE CONTROL

When in a Cooling mode, Press COOLING MULTI-ZONE CONTROL on the Target temperature page to enter the multi-zone control centre:



1	Press to set the cooling target water temperature
2	Press to set the zone 1 target room temperature
3	Press to set the zone 2 target room temperature

STATUS INTERFACE DISPLAY

Swipe from left to right on the Home Screen to enter the Status Display. This will show the current sensor readings and operating state. Swipe from right to left to return to the Home screen.

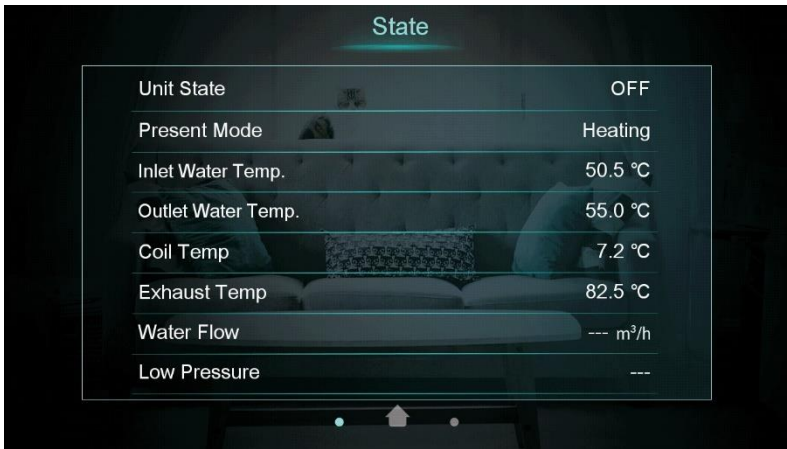

OPTION MENU

Swipe from right to left on the home screen to enter the option menu. To return to the home screen swipe from left to right. The options within the menu are shown below:

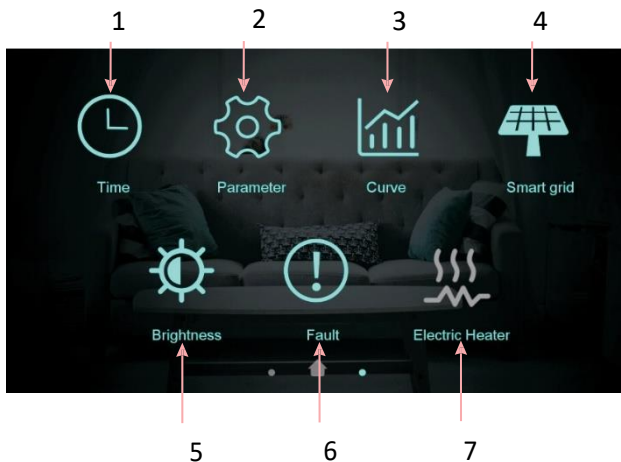

1	Time	Press this button to enter the menu to adjust the time / timers.
2	Parameter	Press the button and enter the password (default: 22) to enter the Parameter menu
3	Curve	Press this button to view the temperature curve menu.
4	Smart grid	Press this button to access the Smart Grid menu
5	Adjust brightness	Press this button to adjust the screen brightness
6	Fault	Press to view fault history
7	Electric heater	Press to turn the electric heater on / off.

The following pages will go through each of the above options.

1. TIME MENU

From the Options menu, press the Time button to enter the Time menu:

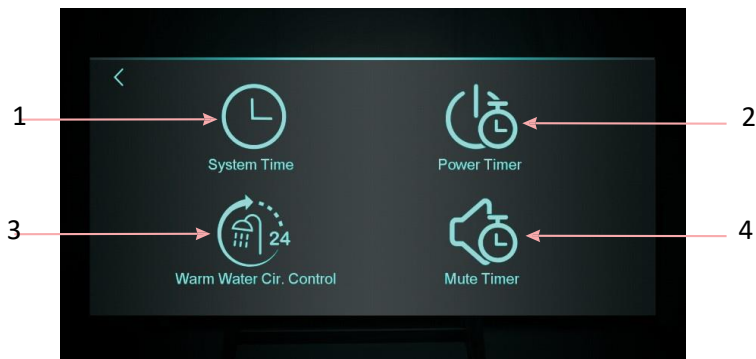

1	System Time	Press to set system time
2	Power Timer	Press to set timed switch on/off
3	Warm Water Cir. Control	Press to set warm water pump timed cycle, hide the icon when H40=0/2, show the icon when H40=1
4	Mute Timer	Press to set timed mute, hide the icon when H22=0, show the icon when H22=1

1.1 SYSTEM TIME SETTING

In the TIME menu, press the SYSTEM TIME button which will take you to the screen to set the date and time:

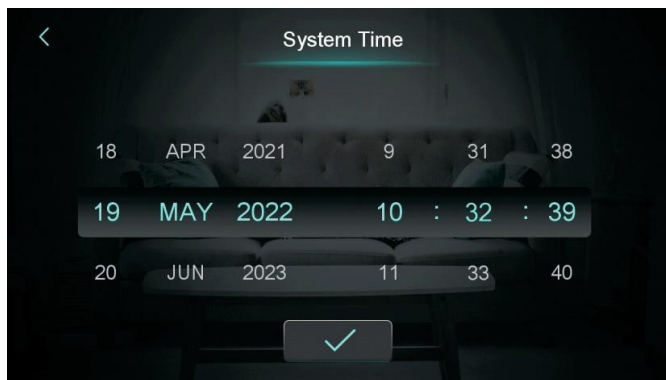

When adjusting the time, the time entered will be set as soon as the tick is pressed. You can adjust the time by sliding up and down.

Note: When the temperature unit is set to °F, the time format is displayed as:
MONTH-DAY-YEAR HOUR: MINUTE: SECOND

1.2 POWER TIMER MENU

In the TIME menu, press the POWER TIMER button which will take you to the power timer interface as below. This allows you to set periods where the whole heat pump will be turned on and off.

This option is ideal if you know there is a large period of time where there will be no-one at home.

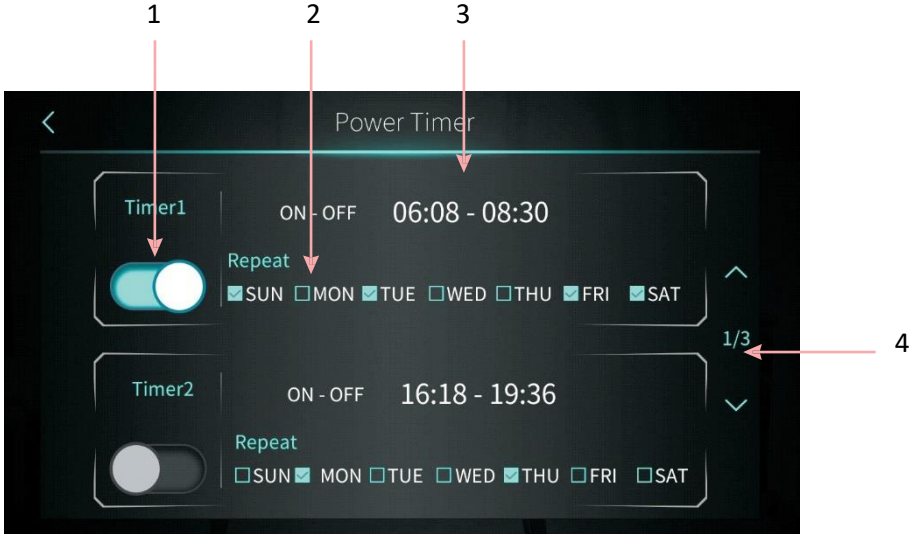

1	Timing switch function on	Press to activate the timer for the period selected.
2	Day	Set which days the operation is applicable to.
3	Time period	Press to set the time to turn on and the time to turn off
4	Turn page	A total of 6 periods of operation can be set, press to scroll to the additional time periods.

1.3 WARM WATER CIRCULATION CONTROL

In the TIME menu, press the Warm Water Cir Control button. Within this menu, just like the power timer, you can select the periods where the heat pump will heat the DHW tank.

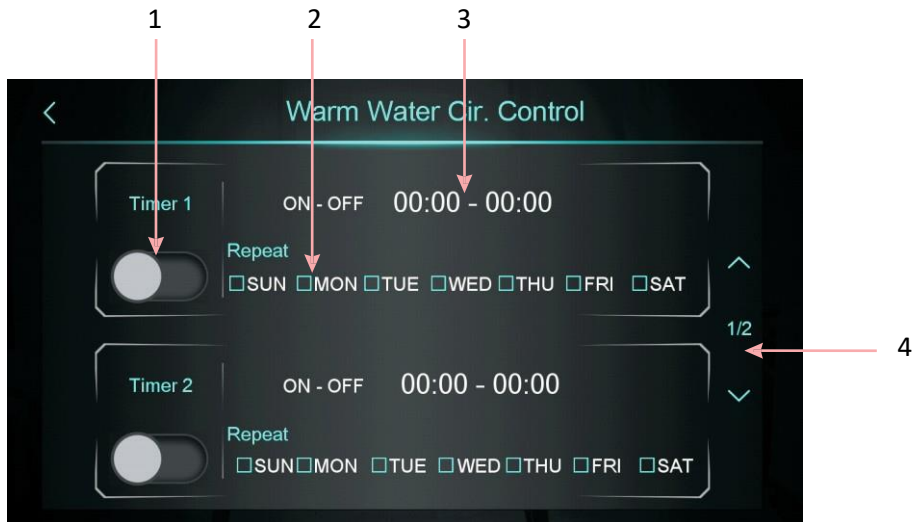

1	Timing switch function on	Press to turn on the timer
2	Week setting	Set the day of the week to activate the timing switch
3	Time period setting	Set the time to turn on and the time to turn off
4	Turn page	A total of 3 timing switch time periods can be set, which can be selected by turning the page

1.4 MUTE TIMER SETTING

In the TIME menu, press the MUTE TIMER button which will take you to the screen to set a period of time that the timer is activated / deactivated.

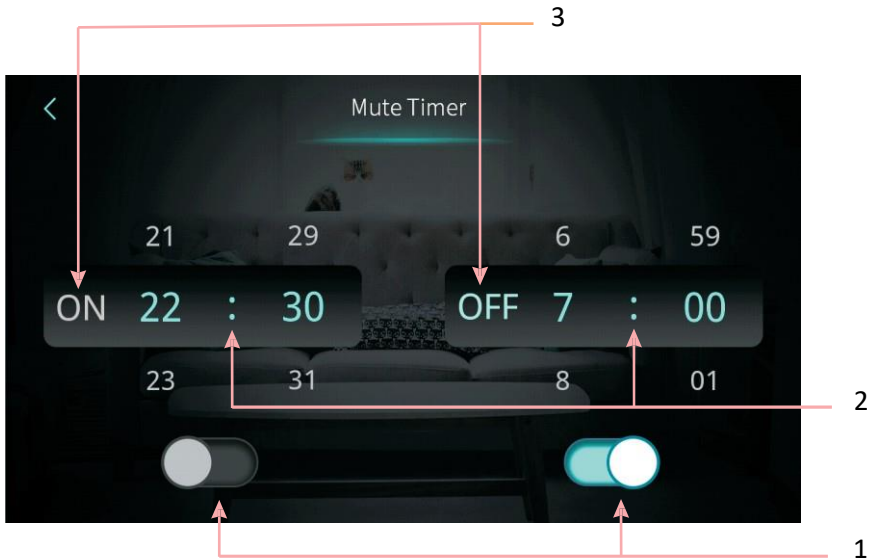

1	Whether enable the mute timer on function	Enable: Blue Disable: Grey	Press this button to enable or disable the mute timer on function
	Whether enable the mute timer off function	Enable: Blue Disable: Grey	Press this button to enable or disable the mute timer on function
2	The mute timer on setting point	/	select from 0:00-23:59
	The mute timer off setting point		select from 0:00-23:59
3	The status of mute timer on	Enable: Blue Disable: Grey	The status of mute timer on is shown
	The status of mute timer off	Enable: Blue Disable: Grey	The status of mute timer on is shown

2. PARAMETER MENU

The parameter menu allows adjustment of the factory parameters. The password is required to access this menu. It is advisable not to adjust the settings within this menu, unless you are confident of the implications.

The Parameter menu provides the status of components, switches and temperatures, as well as allowing you to make adjustment to parameters related to System, Product, Defrost, Temperature, Pump disinfection and Zone.

3. CURVE MENU

From the options menu, press the curve button to enter the temperature curve menu. This menu provides graphs showing the temperature of different parts of the system.

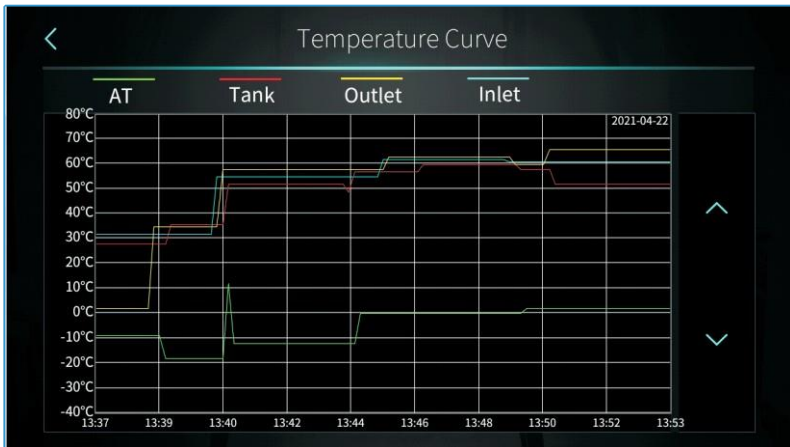

Note:

1. The curve function records the water inlet temperature water outlet temperature, water tank temperature and ambient temperature.
2. Temperature data is collected and saved every five minutes. If the power is lost when the time is less than five minutes, the data during this period will not be saved.
3. The value of the abscissa indicates the time from the point on the curve to the current time point. The right most point on the first page is the latest temperature recorded.
4. Temperature curve record is provided with power-down memory function.

4. SMART GRID MENU

From the options menu, press the Smart Grid button, then the interface display is shown as below:



The Smart Grid ready function is designed to enable you to adjust the settings of the heat pump to work in conjunction with Solar power.

1	Smart grid Ready	Press to enter SG Ready
2	Mode & Temp.& Power	Press to enter Mode & Temp. & Power Timer

4.1 SG READY

The SG ready menu provides you with the options to view the status of the Smart Grid function, and make changes to the operating parameters. When the Smart Grid Ready mode is not activated, the interface will display:

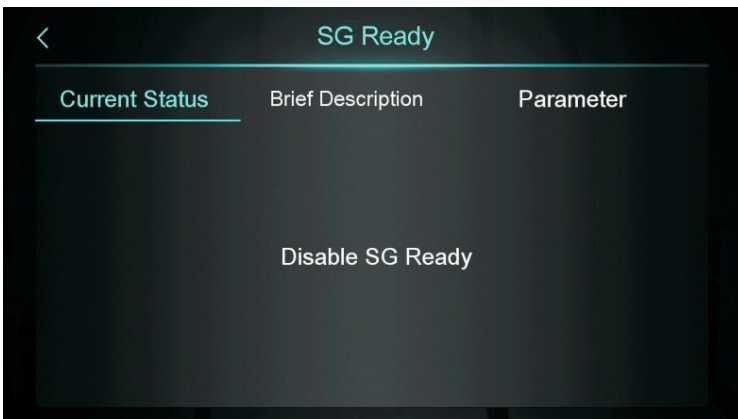

SMART GRID READY - 1

When using one dry contact, the interface will display:

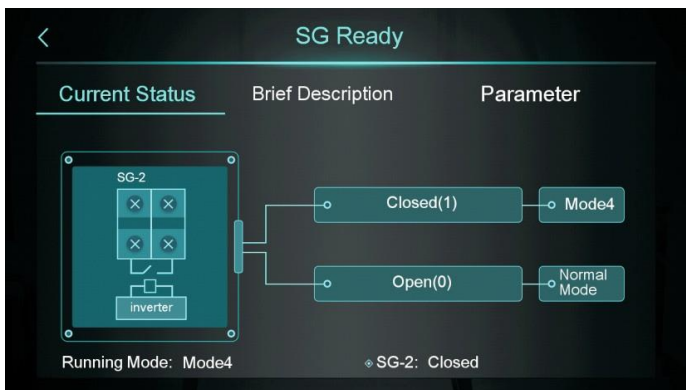

Press "Brief Description" to enter the function description screen:

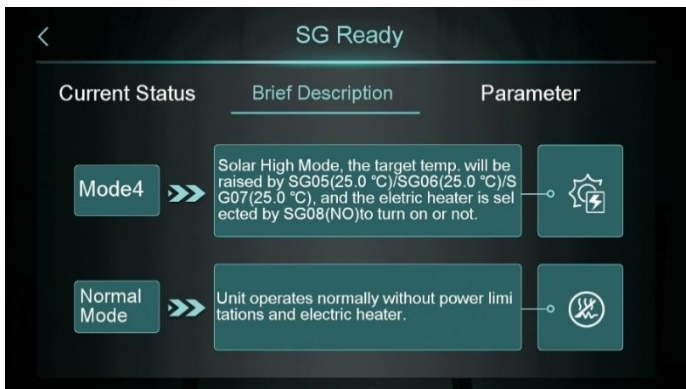

Press "Parameter" and enter the password to enter the parameter setting screen to adjust the performance:



SMART GRID READY - 2

When using two dry contacts, the interface will display:

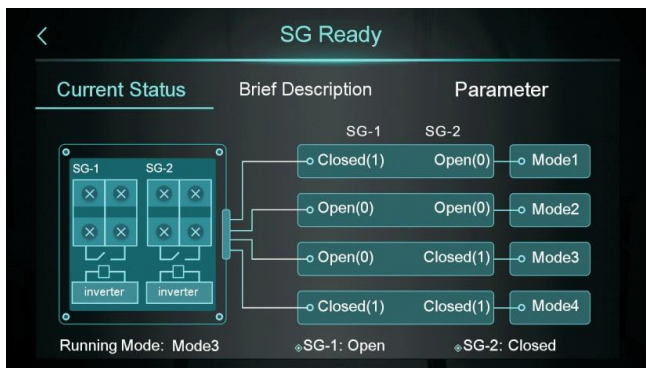

Press "Brief Description" to enter the function description screen:

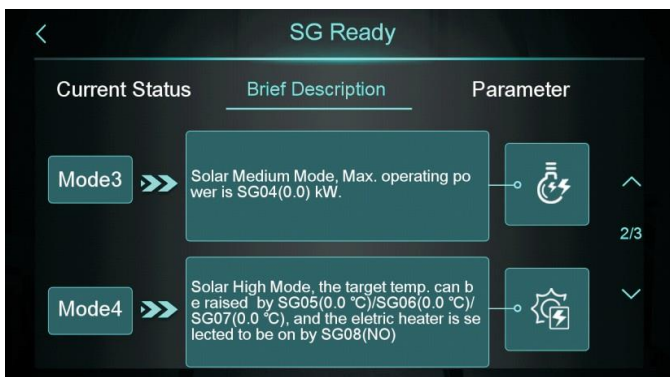

Press "Parameter" and enter the password to enter the parameter setting screen:



4.2 MODE & TEMP POWER TIMER

From the Smart Grid menu the Mode&Temp& Power Timer button to select timed operation for the smart grid function.



1	Enable	Press to turn the timer on
2	Function Description	Press for an explanation of the functions.
3	Time setting	Set the start and end time of the operation
4	Mode	Set the mode for the unit to operate in.
5	Target Temp.	Set target temperature
6	Max. Power	Set the power level (range 0.0~99.9KW) If you don't need to limit the power, please set the "Max. Power" to 0.
7	Days	Set which days the time period operates.
8	Turn page	A total of 6 timer periods can be set, which can be selected by turning the page

5. SCREEN BRIGHTNESS

From the options menu, press the Brightness button, to adjust the screen brightness:

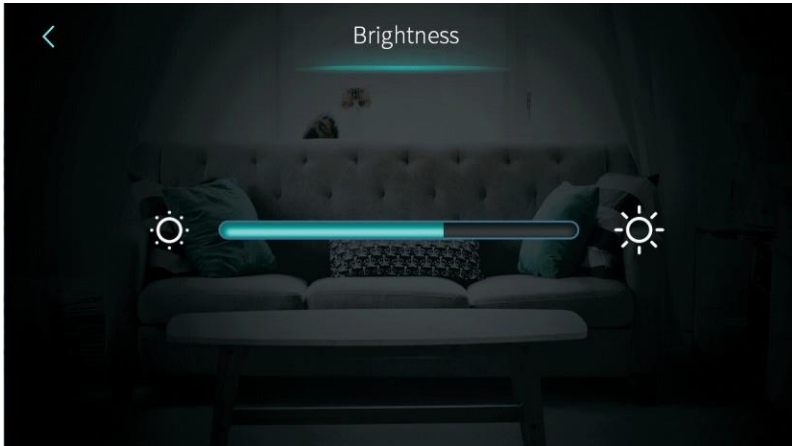

Note:

1. The middle display bar can be dragged or clicked to adjust the brightness of the screen.
2. Press the back button to return to the previous menu and save the brightness.
3. The screen has the function of automatic on and off, if there is no operation for 30s, the screen will enter the standby mode.

6. FAULT RECORD

From the options menu, press the fault button, this will then bring up the record of any fault codes logged:



1. Fault code
2. Fault name
3. When the fault was recorded.
4. Press this button to clear all fault records.

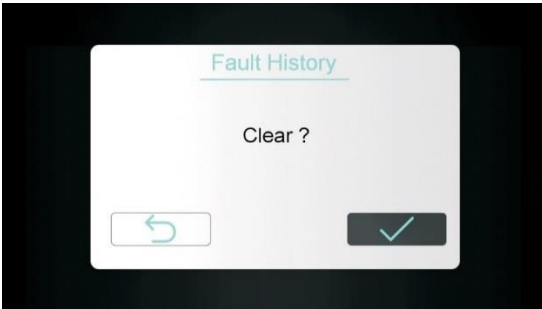

7. ELECTRIC HEATER

In the setup interface, press the heater button to turn the electric heater on or off. On is blue, off is grey.

NOTE: When electric heating is not enabled, the icon is hidden.

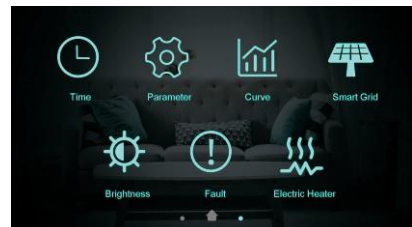
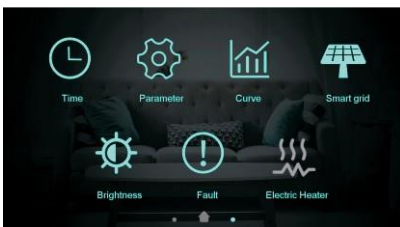

GETTING TO KNOW THE SMART APP

COMMUNICATION MODULE

The heat pump contains a communication module, which it uses to communicate using 4G (mobile phone network) with the cloud to allow control using the WARMLINK app on a mobile phone. The module is found on the side on the unit, next to the power terminals. Included with your heat pump is 4 years of data, allowing remote use of your appliance. This can be extended before the period expires.

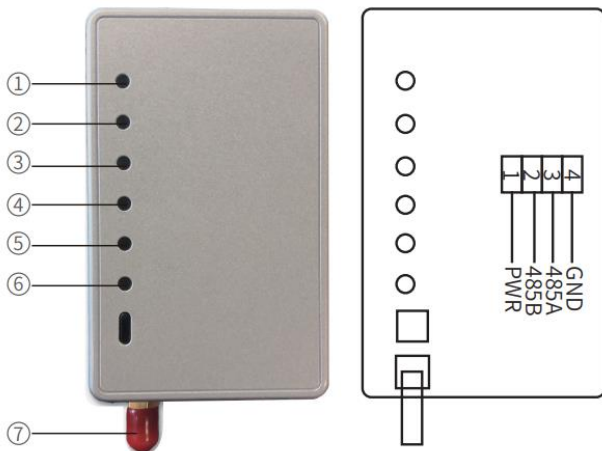

1. Led power indicator
2. Led fault indicator:
The light will be on when the unit fails to communicate with the server mainboard or base station.
3. Led communication indicator:
The light will be on during normal communication with the server the light will flicker, when an error occurs and the light will be off when communication is lost.

SIGNAL INDICATORS:

6. Weak signal.
- 5/6. Intermediate signal.
- 4/5/6. Strong Signal
- 4/5/6. All lights off means weak signal.
7. Antenna, to send or receive signal.

If you live in an area with poor 4G reception, or would prefer to change to a WiFi connection, an optional WiFi communication module (Model number: ecoheat-WiFiDTU) is available to purchase which should be swapped with the pre-fitted 4G module which converts the unit to a 2.4ghz WiFi connection. As the appliance is situated outside, we would advise that you confirm that there is a good level of WiFi coverage in the installation area before converting the unit.

DOWNLOAD THE APP TO YOUR PHONE

Download the "WARMLINK" app, from your chosen app store, using the QR code below, or by searching for the app in your chosen store.



REGISTERING THE APP

Use your email address and password to register, login or reset the password.

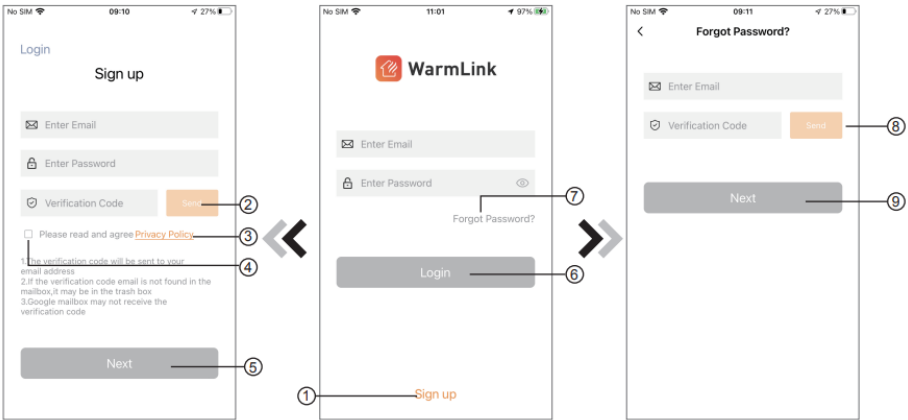

ACCOUNT REGISTRATION:

To register an account, press sign up (1) to go to the Account Registration page, fill in the relevant information and press send (2) to receive verification code.

Press privacy policy (3) to read the details of the Privacy Policy, then tick the box (4) to agree, and press next (5) to confirm your account sign up.





LOG IN:

After account registration, enter your registered email address and password, and press log in (6).

FORGOT PASSWORD:

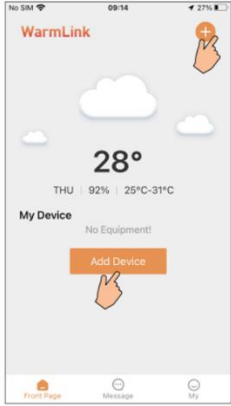
If you ever forget your password, press the forget password button (7). Follow the instructions on the page, fill in the relevant information and press send (8) to receive verification code then after filling in the verification code press next (9) to confirm and password.

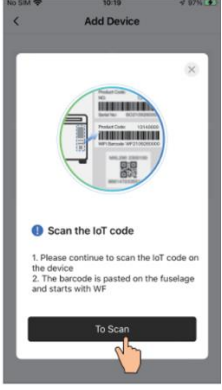
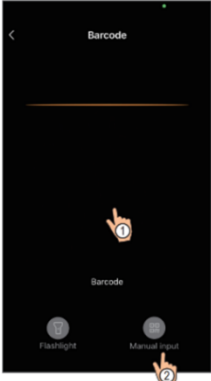
ADDING THE DEVICE

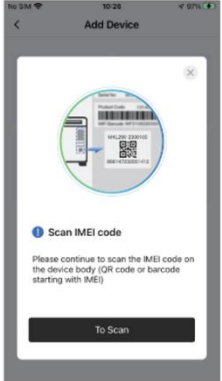
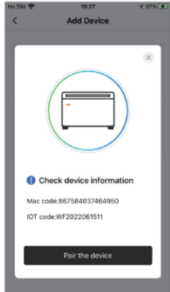
		
<p>1. Press the Add device button within the App.</p>	<p>2. Select the picture of the communication module</p>	<p>3. Scan the WiFi Barcode on the side of the appliance below the rating label</p>
		
<p>4. Instead of Scanning, the Code starting WF below the barcode can also be typed in manually</p>		<p>5. Then Scan the QR code on the communication module.</p>
		<p>6. The app will then confirm that the connection is successful.</p>

USING THE APP

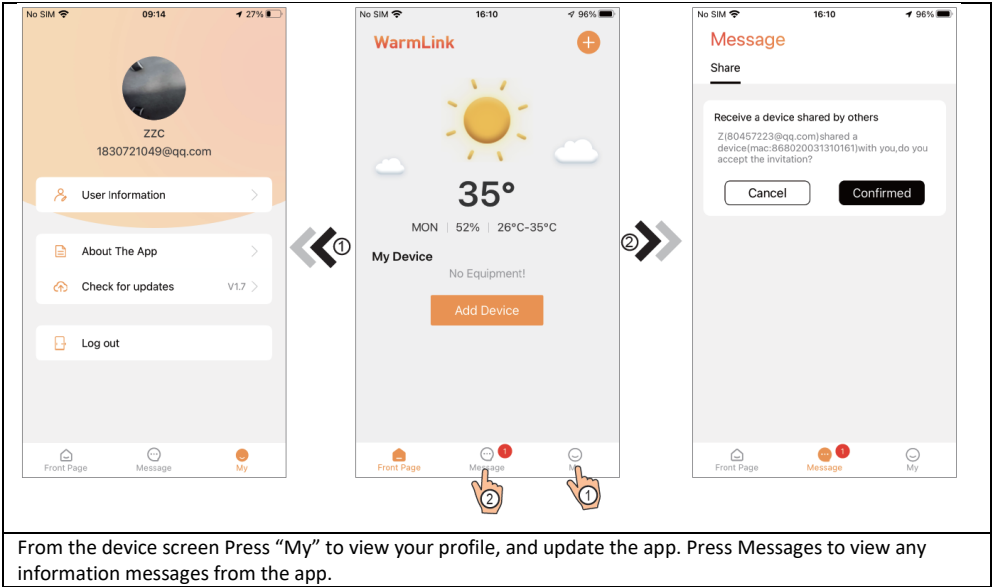

ACCESSING THE DEVICE SCREEN



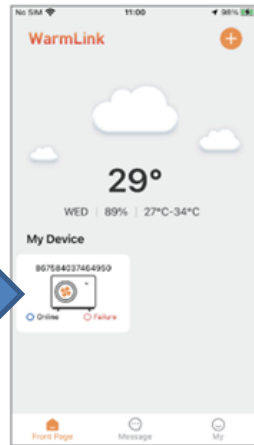
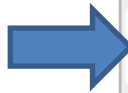



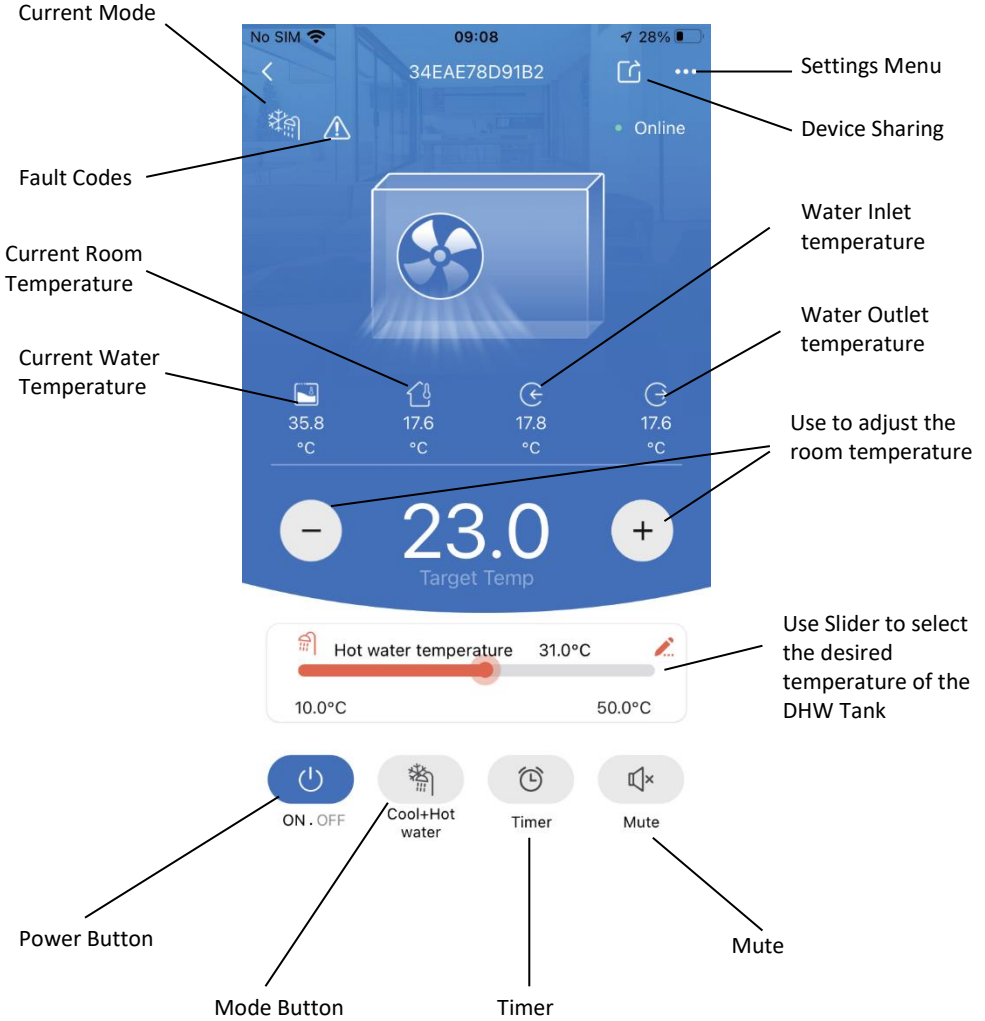











Press on the Device diagram to enter the device control screen.



DEVICE CONTROL SCREEN



APP ICONS

Icon	Name	Function
	On/ off	Click it to turn on/ off the unit
	Silent mode off/on	Displays mute mode. Click to switch mute mode
	Timers settings	Click to enter timer on/of
	Troubleshooting	Click to view device failure information
	Heating and hot water	Select save to change the working mode
	Hot water	Select save to change the working mode
	Heating	Select save to change the working mode
	Refrigeration	Select save to change the working mode
	Refrigeration and hot water	Select save to change the working mode
	Electric heating condition	Display electric heating status
	Defrost status	Display defrost status
	Water flow	Display water flow
	The environment temperature	Display ambient temperature
	Water inlet temperature	Display inlet temperature
	Tank temperature	Display tank temperature
	Indoor temperature	Display room temperature (room temperature)
	Hot water temperature	Display outlet water temperature
	Setting	Click to change the functions setting of the unit

CLEANING AND MAINTENANCE

- **DANGER!** The unit contains R290 flammable refrigerant. Work should only be carried out if it can be conducted without risking damage to the refrigerant circuit. If you are unsure, a suitably qualified engineer must be used.
- Ensure that the unit is kept in a well-ventilated area, to prevent the risks associated with leakage.
- Basic safety rules should be observed when carrying out inspection and/or maintenance on the unit.

CLEANING

- Do not clean the product with a high-pressure cleaner, or water jets.
- Clean the product using a sponge with warm water and a soap solution
- Do not use abrasive cleaners or solvents. Do not use any cleaning agents that contain chlorine or ammonia

BEFORE FIRST USE / AFTER STORAGE

Before starting the unit for the first time, or after a period of non-use, the following should be followed:

- Thoroughly inspect and clean the unit.
- Check the water pump, regulating valve and other parts of the system to ensure they are clean and functioning correctly.
- Ensure all terminals within the system are tight.
- Ensure that the water refill and vent devices are in good condition, as this may affect the performance and reliability of the unit.

PERIODIC MAINTENANCE

Periodic maintenance should be conducted roughly every six months. The power should be disconnected before conducting any maintenance.

- 1) Inspect the heat exchanger, and where necessary they should be cleaned to ensure they are in optimum condition for heat transfer.
- 2) Check the water-side heat exchanger, and where necessary de-scale.
- 3) Check the electrical connections for any signs of deterioration, oxidation or damage. Any parts which are showing signs of excessive wear should be replaced.

CHECKING THE EVAPORATOR, FAN AND CONDENSATE DISCHARGE

- Check whether there is dirt on the fins, if so they should be cleaned using a soft brush to prevent damage.
- Check whether the condensate tray is clean and that water drains through the drain pipe.

REFRIGERANT

Each unit is supplied pre-filled with the correct quantity of refrigerant when leaving the factory. This is not designed to be charged or changed by the end user. Should you suspect a gas leak the product must be disconnected from the mains, and a suitably qualified engineer used to check and if necessary fill the refrigerant circuit. If refilling the unit, the engineer must follow the guidance below:

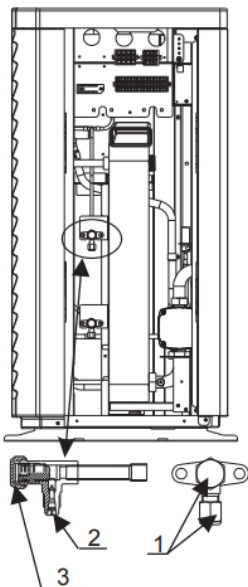

- Keep the unit in a well-ventilated environment while charging the refrigerant.
- Keep away from open flames or potential sources of fire.
- Disconnect the power supply of the heat pump.
- Vacuum the heat pump: Connect the vacuum pump via valve 2, keep vacuum pump running until the absolute pressure below 30Pa or operating time more than one hour.
- Charge refrigerant: Keep the refrigerant in liquid state when charging and strictly according to the labelled amount.
- Finish the charging, close the valve 2 and screw the seal nut 1 and Charge refrigerant. Keep the refrigerant in liquid state when charging and strictly according to the labelled amount.

Finish the charging, close the valve 2 and secure by tightening seal nuts 1

Stop valve signs:
Low pressure

FAULT CODES

The appliance contains a large number of sensors and intelligent logic, enabling it to provide information on any faults or abnormal conditions encountered. These are displayed and logged through the wired controller.

Fault	Display	Reason	Fix
Inlet Water Temp. Sensor Fault	P01	The temp. sensor is broken or short circuit	Check or change the temp. sensor
Outlet Water Temp. Sensor Fault	P02	The temp. sensor is broken or short circuit	Check or change the temp. sensor
DHW Tank Sensor Fault AT	P03	The temp. sensor is broken or short circuit	Check or change the temp. sensor
Sensor Fault	P04	The temp. sensor is broken or short circuit	Check or change the temp. sensor
Suction Temp. Sensor Fault	P17	The temp. sensor is broken or short circuit	Check or change the temp. sensor
Heating Returning Water Temp. Sensor Fault	P013	The temp. sensor is broken or short circuit	Check or change the temp. sensor
DHW Returning Water Temp. Sensor Fault	P018	The temp. sensor is broken or short circuit	Check or change the temp. sensor
Heating Leaving Water Temp. Sensor Fault	P023	The temp. sensor is broken or short circuit	Check or change the temp. sensor
DHW Leaving Water Temp. Sensor Fault	P028	The temp. sensor is broken or short circuit	Check or change the temp. sensor
Room Temp. Sensor Fault	P42	The temp. sensor is broken or short circuit	Check or change the temp. sensor
EVI Inlet Sensor Fault	P101	The temp. sensor is broken or short circuit	Check or change the temp. sensor
EVI Outlet Sensor Fault	P102	The temp. sensor is broken or short circuit	Check or change the temp. sensor
Distributor Tube Temp. Sensor Fault	P152	The temp. sensor is broken or short circuit	Check or change the temp. sensor
Coil Temp. Sensor Fault	P153	The temp. sensor is broken or short circuit	Check or change the temp. sensor
Exhaust Temp. Sensor Fault	P181	The temp. sensor is broken or short circuit	Check or change the temp. sensor
Over high Exhaust Temp.	P182	The compressor is overload	check whether the system of the compressor running normally
Anti-freezing Temp. Sensor Fault	P191	The temp. sensor is broken or short circuit	Check or change the temp. sensor
Mix Tube Outlet Water Temp. Sensor Fault	P02a	The temp. sensor is broken or short circuit	Check or change the temp. sensor
Buffer Tank Temp. Sensor Fault	P03a	The sensor is broken or short circuit	Check or change the temp. sensor
Pressure Sensor Fault	PP11	The pressure sensor is broken or short circuit	Check or change the pressure sensor or pressure
High Pressure Sensor Fault	PP12	The pressure sensor is broken or short circuit	Check or change the pressure sensor or pressure
Low AT Protection	TP	The ambient temp. is low	Check the ambient temp value
No Cooling at Low AT Protection	TC		Check or change the pressure sensor or pressure
Electric Heater Overheat Fault	E04	The protection switch is broken electric-heater	Check whether the electric heater runs at the temperature above 150°C for a long time
Excess Temp. Diff. Between Inlet & outlet	E06	Water flow is not enough and low differential pressure	Check the pipe water flow and whether water system is jammed or not
Communication Fault	E08	Communication failure between wire controller and mainboard	Check the wire connection between remote wire controller and main board
Primary Anti-freezing Fault	E19	The ambient temp. is low	Check the ambient temp value
Secondary Anti-freezing Fault	E29	The ambient temp. is low	Check the ambient temp value

Insufficient Defrosting Water Flow Alarm	E030	The unit flow rate is less than the minimum flow value of the unit.	Check or change waterway systems to provide unit flow
Flow Switch Fault	E032	No water/little water in water system	Check the pipe water flow and water pump
Over high Outlet Water Temp.	E065	No water/little water in water system	Check the pipe water flow and water pump
Low Outlet Water Temp. Temp. Fault	E071	No water/little water in water system	Check the pipe water flow and water pump
Fan Motor 1 and PCB Communication Fault	E081	Speed control module and main board communication fail	Check the communication connection
Fan Motor 2 and PCB Communication Fault	E082	Speed control module and main board communication fail	Check the communication connection
Display and PCB Communication Fault	E084	The wire controller software is not matching the mainboard software	Check the wire control software number and the mainboard software number
Communication Fault with Hydraulic Module	E08c	Hydraulic Module and mainboard communication fail	Check the communication connection
HP Fault	E11	The high-pressure switch is broken	Check the pressure switch and cold circuit
LP Fault	E12	The low-pressure switch is broken	Check the pressure switch and cold circuit
Anti-freezing Fault	E171	Use side water system temp. is low	1.Check the water temp. or change the temp. sensor 2.Check the pipe water flow and whether water system is jammed or not
Fan Motor1 Fault	F031	1. Motor is in locked-rotor state 2.The wire connection between DC-fan motor module and fan motor is in bad contact	1.Change a new fan motor 2.Check the wire connection and make sure they are in good contact
Fan Motor2 Fault	F032	1. Motor is in locked-rotor state 2.The wire connection between DC-fan motor module and fan motor is in bad contact	1.Change a new fan motor 2.Check the wire connection and make sure they are in good contact
Zone 1 Room Temp. Sensor Fault	P105	The temp. sensor is broken or short circuit	Check or change the temp. sensor
Zone 2 Room Temp. Sensor Fault	P106	The temp. sensor is broken or short circuit	Check or change the temp. sensor
Zone 2 Mixing Temp. Sensor Fault	P107	The temp. sensor is broken or short	Check or change the temp. sensor circuit
Abnormal Adjustment of Mixing Valve	E122	1. Mixing Valve is incorrectly connected; 2. Mixing Valve is damaged;	1. Plug and unplug terminals; 1. Replace the Mixing Valve;
Zone 1 Thermostat Communication Fault	E08g	1. Thermostat not connected 2. Thermostat failure 3.Wrong parameter setting	1. Check the wiring connection between the thermostat and the unit 2. Replace the thermostat 3.Check the parameters
Zone 2 Thermostat Communication Fault	E08h	1. Thermostat not connected 2. Thermostat failure 3.Wrong parameter setting	1. Check the wiring connection between the thermostat and the unit 2. Replace the thermostat 3.Check the parameters
Low Water Flow Protection	E035	Water flow is too low	Increased water flow

FREQUENCY CONVERSION BOARD FAULT TABLE:

Fault	Display	Reason	Fix
IPM Overcurrent Fault	F00	IPM Input current is large	Check and adjust the current measurement
Comp. Driver Fault	F01	Lack of phase, step or drive hardware damage	Check the measuring voltage check frequency conversion board hardware
Pre-Charge Failure	F03	The PFC circuit protection	Check the PFC switch tube short circuit or not
DC Power Bus Overvoltage Fault	F05	DC bus voltage>Dc bus Overload-voltage protection value	Check the input voltage measurement
DC Power Bus Undervoltage	F06	DC bus voltage<Dc bus Underload-voltage protection value	Check the input voltage measurement
AC Power Undervoltage Fault	F07	The input voltage is low, causing the input current is low	Check the input voltage measurement
AC Power Overcurrent Fault	F08	The input voltage is too high, more than outage protection current RMS	Check the input voltage measurement
Input Power Voltage Sampling Fault	F09	The input voltage sampling fault	Check and adjust the current measurement
DSP and PFC Communication Fault	F12	DSP and PFC connect fault	Check the communication connection
DSP and Comp. Driver Communication Fault	F11	DSP and Inverter board communication failure	Check the communication connection
Comp. Driver and PCB Communication Fault	F151	DSP and Mainboard communication failure	Check the communication connection
IPM Overheat Fault	F13	The IPM module is overheat	Check and adjust the current measurement
Comp. Overcurrent Fault	E051	The compressor is overload	Check whether the system of the compressor running normally
Input Power Lacking Phase Fault	F15	The input voltage lost phase	Check and measure the voltage adjustment
IPM Current Sampling Fault	F18	IPM sampling electricity is fault	Check and adjust the current measurement
Comp. Driver Temp. Sensor Fault	F17	The transducer is overheated	Check and adjust the current measurement
IGBT Power Device Overheat Alarm	F20	The IGBT is overheat	Check and adjust the current measurement
Comp. Weak Magnetic Alarm	F16	Compressor magnetic force is not enough	Check and adjust the current measurement
AC Input Current Frequency Decrease alarm	F22	Input current is too large	Check and adjust the current measurement
EEPROM Alarm	F23	MCU error	Check whether the chip is damaged Replace the chip
Destroyed EEPROM & No Activated Fault	F24	MCU error	Check whether the chip is damaged Replace the chip

Input Power Current Sampling Fault	F25	The V15V is overload or undervoltage	Check the V15V input voltage in range 13.5V~16.5V or not
IGBT Overheat Fault	F26	The IGBT is overheated	Check and adjust the current measurement
Comp. Current Frequency Decrease Alarm	F33	The compressor current frequency reduction	Check and adjust the current measurement
AC Power Overvoltage Fault	F10	Input voltage>Input Overload-voltage protection value	Check whether the input voltage is higher than 265V
Compressor Lacking Phase Fault	F14	The compressor lost phase	Check whether compressor cables are connected properly and reliably
EEPROM Fault	F29	Failed to read the memory chip	Check the frequency conversion board
Overspeed Fault	F21	The compressor is running abnormally	Check whether the compressor cable is normal and whether the compressor is blocked
Driver (Fan)Temp . Sensor Fault	F120	The temp. sensor is broken or short circuit	Check or change the temp. sensor
Driver (Fan)IPM Overheat Fault	F106	The fan IPM drive plate has poor heat dissipation	Check heat dissipation conditions
Driver (Fan) External Overcurrent Fault	F105	The fan IPM hardware running current is too large	Check whether the fan is blocked
Driver (Fan) Power Lacking Phase Fault	F101	The fan lost phase	Check whether fan cables are connected properly and reliably
Driver (Fan) Current Sampling Fault	F112	Fan sampling electricity is fault	Check whether the fan drive plate is abnormal
Driver (Fan) Start Fault	F102	The fan fails to start	Check whether the fan is blocked
Driver (Fan) Internal Overcurrent Fault	F113	The fan software running current is too large	Check whether the fan is blocked
Driver (Fan) overspeed Fault	F109	The fan speed is too high	Check whether the fan drive board is abnormal

PARAMETER LIST

Meaning	Default	Remarks
Cooling target temperature set point	12°C	Adjustable
Heating the target temperature set point	45°C	Adjustable
Hot water target temperature set point	55°C	Adjustable

ECOHEAT-MHP22	
CE1	Control temperature
CE2	Control temperature
CE3	Control temperature
CE4	Control temperature
CE5	Control temperature
CE6	Control temperature
CE7	Control temperature
CE8	Control temperature
CE9	Control temperature
CE10	Control temperature
CE11	Control temperature
CE12	Control temperature
CE13	Control temperature
CE14	Control temperature
CE15	Control temperature
CE16	Control temperature
CE17	Control temperature
CE18	Control temperature
CE19	Control temperature
CE20	Control temperature
CE21	Control temperature
CE22	Control temperature
CE23	Control temperature
CE24	Control temperature
CE25	Control temperature
CE26	Control temperature
CE27	Control temperature
CE28	Control temperature
CE29	Control temperature
CE30	Control temperature
CE31	Control temperature
CE32	Control temperature
CE33	Control temperature
CE34	Control temperature
CE35	Control temperature
CE36	Control temperature
CE37	Control temperature
CE38	Control temperature
CE39	Control temperature
CE40	Control temperature
CE41	Control temperature
CE42	Control temperature
CE43	Control temperature
CE44	Control temperature
CE45	Control temperature
CE46	Control temperature
CE47	Control temperature
CE48	Control temperature
CE49	Control temperature
CE50	Control temperature
CE51	Control temperature
CE52	Control temperature
CE53	Control temperature
CE54	Control temperature
CE55	Control temperature
CE56	Control temperature
CE57	Control temperature
CE58	Control temperature
CE59	Control temperature
CE60	Control temperature
CE61	Control temperature
CE62	Control temperature
CE63	Control temperature
CE64	Control temperature
CE65	Control temperature
CE66	Control temperature
CE67	Control temperature
CE68	Control temperature
CE69	Control temperature
CE70	Control temperature
CE71	Control temperature
CE72	Control temperature
CE73	Control temperature
CE74	Control temperature
CE75	Control temperature
CE76	Control temperature
CE77	Control temperature
CE78	Control temperature
CE79	Control temperature
CE80	Control temperature
CE81	Control temperature
CE82	Control temperature
CE83	Control temperature
CE84	Control temperature
CE85	Control temperature
CE86	Control temperature
CE87	Control temperature
CE88	Control temperature
CE89	Control temperature
CE90	Control temperature
CE91	Control temperature
CE92	Control temperature
CE93	Control temperature
CE94	Control temperature
CE95	Control temperature
CE96	Control temperature
CE97	Control temperature
CE98	Control temperature
CE99	Control temperature
CE100	Control temperature

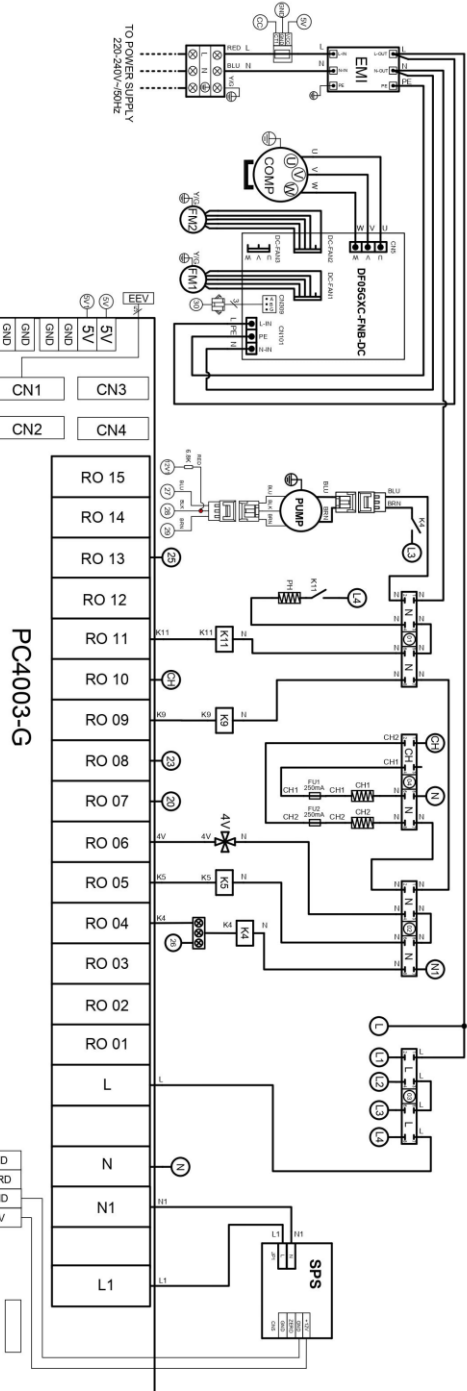
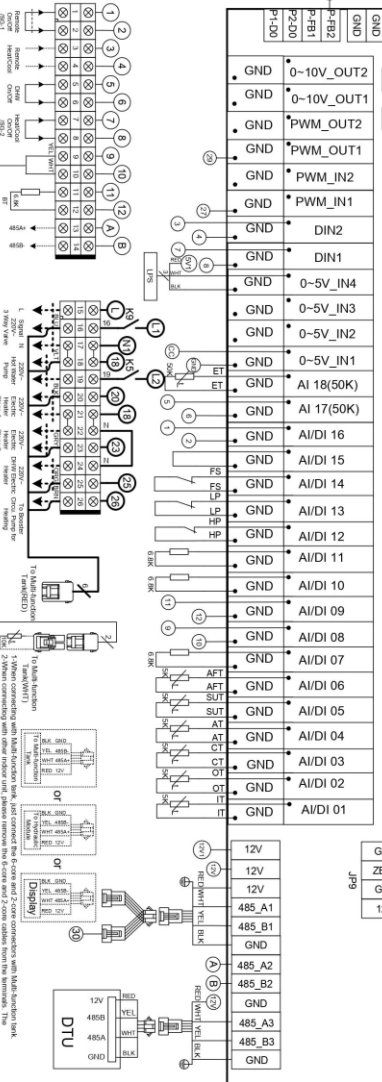

MAIN BOARD CONNECTORS

No	Label	Meaning	NO	Label	Meaning
01	AI/DI01	Inlet Water Temp.	32	+12V	12V output
02	AI/DI02	Outlet Water Temp.	33	CN1	EEV Steps
03	AI/DI03	Coil Temp.	34	CN2	EVI EEV Steps
04	AI/DI04	Ambient Temp. (AT)	35	CN3	Reserved
05	AI/DI05	Suction Temp.	36	CN4	Reserved
06	AI/DI06	Antifreeze Temp.	37	CN300	Program port
07	AI/DI07	Zone 1 room temp./Zone 1-P	38	JP5_1	5-inch color display/DC fan speed regulation module/ Frequency conversion board/Hydraulic module
08	AI/DI08	DHW Tank Temp.	39	JP5_2	Centralized control communication port
09	AI/DI09	Room Temp. /Buffer Tank Temp.	40	JP5_3	DTU/WIFI/Thermostat 1/Thermostat 2
10	AI/DI10	EVI Inlet Temp.	41	RO01	Compressor
11	AI/DI11	EVI Outlet Temp.	42	RO02	Zone 2 Mixing valve Open
12	AI/DI12	High Pressure Switch	43	RO03	Zone 2 Mixing valve Closed
13	AI/DI13	Low Pressure Switch	44	RO04	Main Circulation Pump
14	AI/DI14	Flow Switch	45	RO05	DHW Pump
15	AI/DI15	Zone 2 Water Temp. after Mixing	46	RO06	4-way valve
16	AI/DI16	Remote Switch/SG-1	47	RO07	Electric Heater Stage 1
17	AI/17 (50k)	DHW Switch/Zone 2 room temp./Zone 2-P	48	RO08	Electric Heater Stage 2
18	AI/18 (50K)	Exhaust Temp.	49	RO09	Hot water 3-way valve
19	0~5V_IN1	Transformer Current 1	50	RO10	Crankcase Heater
20	0~5V_IN2	Transformer Current 2	51	RO11	Bottom Plate Heater
21	0~5V_IN3	Transformer Current 3	52	RO12	Cooling 3-Way Valve
22	0~5V_IN4	Low Pressure	53	RO13	DHW Electric Heater
23	DIN_1	Heating & Cooling Function Switch	54	RO14	Zone 1 pump
24	DIN_2	Heating / Cooling Mode Switch	55	RO15	Zone 2 pump
25	PWM_IN1	Water Flow Rate	56	JP9	12V input
26	PWM_IN2	Reserved	57	CN7	Reserved
27	PWM_OUT1	Heating & Cooling Function Switch Output	58	P_FB2	Reserved
28	PWM_OUT2	Heating / Cooling Mode Switch Output	59	P_FB1	Reserved
29	0~10V_OUT1	Mixing valve output	60	P2_DO	Reserved
30	0~10V_OUT2	Reserved	61	P1_DO	Reserved
31	+5V	5V output			

NOTE:

JP5_1 represents +12V, 485_A1, 485_B1, GND on the JP5 terminal; JP5_2 represents +12V, 485_A2, 485_B2, GND on the JP5 terminal; JP5_3 represents +12V, 485_A3, 485_B3, GND on the JP5 terminal.

WATER QUALITY REQUIREMENTS

Corrosive resistance of stainless steel and brazed materials in tap water at room temperature

+	Good corrosion resistance under normal conditions
0	There may be corrosion - Not recommended

Moisture	Concentration	Time limit	Plate material			Brazing material		
			AISI 304	AISI 316	254 SMO	Cuprum	Nickel	SS
Alkalinity (HCO ⁻³)	<70	24h	+	+	+	0	+	+
	70-300		+	+	+	+	+	+
	>300		+	+	+	0/+	+	+
Sulphate (So ⁻²⁻⁴)	<70	unlimited	+	+	+	+	+	+
	70-300		+	+	+	0/-	+	+
	>300		+	+	+	-	+	+
HCO/SO ²⁻³	>1.0	unlimited	+	+	+	+	+	+
	<1.0		+	+	+	0/-	+	+
Electrical conductivity	<10	unlimited	+	+	+	0	+	+
	10-500		+	+	+	+0	+	+
	>500		+	+	+	+	+	+
pH	<6.0	24H	0	0	0	0	+	0
	6.0-7.5		+	+	+	0	+	+
	7.5-9		+	+	+	0	+	+
	>9		+	+	+	+0	+	+
Ammonium (NH ⁺)	<2	24H	+	+	+	+0	+	+
	2-20		+	+	+	-	+	+
	>20		+	+	+	+	+	+
Chloride (Cl ⁻)	<10	unlimited	+	+	+	+	+	+
	100-200		0	+	+	+	+	+
	200-300		-	+	+	+	+	+
	>300		-	-	+	0/+	+	-

Disposal: Do not dispose of this product as unsorted waste. Collection of such waste must be handled separately as special treatment is necessary.



Recycling facilities are now available for all customers at which you can deposit your old electrical products. Customers will be able to take any old electrical equipment to participating sites run by their local councils. Please remember that this equipment will be further handled during the recycling process, so please be considerate when depositing your equipment. Please contact the local council for details of your local household waste recycling centre

TECHNICAL DATA

Supplier Model		ECOHEAT-MHP9	ECOHEAT-MHP15	ECOHEAT-MHP22
Heating Capacity	kW	3.10~8.90	5.40~14.95	8.00~22.00
Heating Power Input	kW	0.65~2.10	1.05~3.85	1.60~6.90
Cooling Capacity	kW	1.20~5.72	3.60~10.50	4.20~15.00
Cooling Power Input	kW	0.65~2.40	1.12~4.47	1.80~7.30
Hot Water Capacity	kW	3.92~10.68	6.50~18.50	10.00~27.00
Hot Water Power Input	kW	0.78~2.47	1.27~4.65	1.90~7.10
Max Power Input	kW	3.0	5.30	7.5
Max Current Input	A	13.5	24.5	35.0
Power Supply		220-240V~/50Hz	220-240V~/50Hz	220-240V~/50Hz
Power Cable CSA		3x2.5mm ²	3x4.0mm ²	3x10mm ²
MCB Rating	A	32	40	63
Compressor Quantity		1	1	1
Compressor Model		Rotary	Rotary	Rotary
Fan Quantity		1	1	2
Fan Power Input	W	150	170	75
Fan Rotate Speed	RPM	600	600	600
Water Pump Input	W	60	60	160
Noise	dB(A)	38~52	39~52	42~54
Water Connection	Inch	1	1	1
Water Flow Volume	M3/h	1.0	1.7	2.9
Internal Water Pressure Drop	kPa	20	30	45
Water Head	M	5.0	5.5	6.9
Unit Shipping Dimensions LxWxH	mm	1300x485x940	1420x540x1080	1380x570x1480
Net Weight	Kg	102	160	202

Cooling working condition:(DB/WB)35°C/24° (Outlet/Inlet) 7°C /12°C .

Heating working condition:(DB/WB) 7°C /6°C . (Outlet/Inlet) 35°C /30°C . Hot Water working condition:(DB/WB): 20°C /15°C, water tank temperature circulation from 15°C to 55°C.

PERFORMANCE TABLES

EcoHeat-MHP9				
Ambient Temperature (°C)	Water Temperature (°C)	Power Input (W)	Heating Capacity (W)	COP/EER (W/W)
-10	35	1966	5547	2.78
-10	55	2526	4556	1.8
7	35	2111	8715	4.13
10	35	1786	8302	4.65
10	55	2225	6286	2.83
20	35	1752	9675	5.52
20	55	2286	7404	3.24
35	7	2497	5634	2.26

EcoHeat-MHP15				
Ambient Temperature (°C)	Water Temperature (°C)	Power Input (W)	Heating Capacity (W)	COP/EER (W/W)
-10	35	3525	9790	2.78
-10	55	4367	8809	2.02
7	35	3849	15033	3.91
10	35	3533	15480	4.38
10	55	4616	13872	3.01
20	35	3204	16432	5.13
20	55	3973	13506	3.40
35	7	4809	10102	2.10

EcoHeat-MPH22				
Ambient Temperature (°C)	Water Temperature (°C)	Power Input (W)	Heating Capacity (W)	COP/EER (W/W)
-10	35	5319	14686	2.76
-10	55	6500	13650	2.1
7	35	5843	22354	3.83
10	35	5515	23691	4.3
10	55	7314	22382	3.06
20	35	4869	24284	4.99
20	55	5925	20509	3.46
35	7	7441	15243	2.05

Note: These tables are for guidance only, based on in house tests. Real world performance may vary depending on a number of factors.

UK SUPPORT

energysupport@buyitdirect.co.uk
Call: 0330 390 3062

Office hours: 9AM - 5PM Monday to Friday

Buy It Direct (Importer)
Unit 2A, Trident Business Park,
Neptune Way, Leeds Road, Huddersfield, HD2 1UA

V20231116